

**Technical specification of external interfaces
for market participants**

V1.1~~87~~

**MARKET ORGANIZER
INFORMATION SYSTEM
XMtrade®/ISOT**



sféra, a.s. • Karadžičova 2 • 811 08 Bratislava
tel.: +421 2 502 13 142 • fax: +421 2 502 13 262

© sféra, a.s., 2022

TABLE OF CONTENT

1	INTRODUCTION	6
1.1	<i>Characteristics of the document</i>	6
1.1.1	Purpose of the document.....	6
1.1.2	Specification of the document.....	6
2	OVERVIEW OF EXTERNAL INTERFACES	7
2.1	<i>Overview of data flows</i>	7
2.1.1	Organization of domestic day-ahead market.....	7
2.1.2	Coordinated organization of day-ahead market	8
2.1.3	Organizing domestic intraday market.....	10
2.1.4	Coordinated organization of intraday market.....	13
2.1.5	Coordinated organization of intraday auctions	17
3	SPECIFICATION OF COMMUNICATION	18
3.1	<i>Web services</i>	18
3.1.1	Communication scenarios	18
3.1.2	SOAP Protocol.....	19
3.1.3	Orders	20
3.1.4	IdmOrders	24
3.1.5	IdmOrderBook.....	29
3.1.6	IdaOrders	32
3.1.7	Evaluations	35
3.1.8	IdmEvaluations	37
3.1.9	IdaEvaluations	39
3.1.10	StatusRequest	41
3.1.11	Communication Security.....	43
3.1.12	Description of web services	46
3.2	<i>AMQP interface</i>	4848484847
3.2.1	AMQP Protocol	4848484847
3.2.2	Connecting to RabbitMQ server	4949494948
3.2.3	Communication scenarios	4949494948
3.2.4	Communication security	50
3.2.5	Message format	5151515150
3.2.6	AMQP server	51
4	SPECIFICATION OF DATA STRUCTURES	5353535352
4.1	<i>Common data structures</i>	5555555554
4.1.1	ISOTEDATA.....	5555555554
4.1.2	ISOTEDATA-VDT	7474747473
4.1.3	RESPONSE	8181818180
4.1.4	RESPONSE-VDT	8484848483
4.1.5	CDSREQ.....	8686868685
4.1.6	CDSREQ-VDT	8888888887
4.2	<i>Administration of DAM orders</i>	9090909089
4.2.1	Processing level.....	9090909089
4.2.2	Reception of orders (E-02_01)	9191919190
4.2.3	Removal of orders (E-02_01)	9393939392
4.2.4	Order modification (E-02_01)	9696969695
4.2.5	Provision of orders (E-02_03).....	10010010010099
4.3	<i>Administration of Intraday Market orders</i>	103103103103102
4.3.1	Processing level.....	103103103103102
4.3.2	Reception of orders (E-06_01)	106106106106105
4.3.3	Modification of orders (E-06_02)	108108108108107
4.3.4	Provision of orders (E-06_03).....	109109109109108

4.4	<i>Administration of intraday order book</i>	110110110110109
4.4.1	Processing level.....	110110110110109
4.4.2	The order book data (E-08_01)	111111111111110
4.4.3	Available cross-border transmission capacities data H2H (E-08_02) ...	117117117117116
4.5	<i>Administration of IDA orders</i>	120120120120119
4.5.1	Processing level.....	120120120120119
4.5.2	Reception of orders (E-09_01)	120120120120119
4.5.3	Removal of orders (E-09_01)	123123123123122
4.5.4	Order modification (E-09_01)	126126126126125
4.5.5	Provision of orders (E-09_02).....	132132132132131
4.6	<i>DM results and evaluations</i>	133133133133132
4.6.1	Processing level.....	133133133133132
4.6.2	Notification of results for market participants (E-03_02)	133133133133132
4.6.3	Notification of evaluations per hours (E-05_01)	135135135135134
4.6.4	Notification of evaluation for a day (E-05_02)	137137137137136
4.7	<i>Evaluation of IDM</i>	139139139139138
4.7.1	Processing level.....	139139139139138
4.7.2	Notice of an evaluation for a day (E-07_01)	139139139139138
4.7.3	Notice of an evaluation for a month (E-07_02).....	140140140140139
4.7.4	Notice of evaluation for time periods (E-07_03).....	142142142142141
4.8	<i>AMQP notifications</i>	144144144144143
4.8.1	Processing level.....	144144144144143
4.8.2	Status change/Creation of own order (E-10_01).....	145145145145144
4.8.3	Change of the order book data (E-10_02).....	148148148148147
4.8.4	Change in cross-border capacities data H2H (E-10_03).....	153153153153152
4.9	<i>IDA results and evaluations</i>	154154154154153
4.9.1	Processing level.....	154154154154153
4.9.2	Notification of results for market participants (E-11_01)	154154154154153
4.9.3	Notification of evaluations per periods (E-11_01).....	157157157157156
4.9.4	Notification of evaluations per day (E-05_02).....	160160160160159
4.10	<i>Retrieval of MCC values</i>	161161161161160
4.10.1	Processing level.....	161161161161160
4.10.2	Notification of MCC values (E-01_02)	161161161161160
4.10.3	ESR.StatusRequest	162162162162161
4.10.4	EAD.Acknowledgement	163163163163162
4.10.5	ECAN.CapacityDocument	166166166166165
5	LIST OF FIGURES	172172172172171
6	LIST OF TABLES	173173173173172
7	LIST OF EXAMPLES	175175175175174

History of Changes

Date	Version	Description	Author
6/1/2009	1.0	Document processing	Mgr. Miroslav Galajda, Mgr. Libor Láznička
6/3/2009	1.1	Update of order structure	Mgr. Miroslav Galajda
7/1/2009	1.2	Detailed clarification of information to provided results and evaluations of DM. Elaboration of examples to individual data flows. Refinement of SOAP header specification. Payments and fees are specified excluding VAT and tax on electricity.	Mgr. Miroslav Galajda, Mgr. Libor Láznička
8/18/2009	1.3	Addition of service specification for publication of MCC values for market participant.	Mgr. Miroslav Galajda
1/27/2012	1.4	Introduction of negative prices on DM.	Bc. Anton Weissensteiner
12/3/2014	1.5	Hyperlinks change to a new web address: https://isot.okte.sk , https://test-isot.okte.sk .	Mgr. Svetlana Pražienková
2/3/2015	1.6	Description of processes correction in accordance with 4MMC – CZ/SK/HU/RO project.	Ing. Jozef Drgoňa
2/23/2016	1.7	Addition of specification for orders on intraday market and results retrieval of intraday for market participant	Ing. Jozef Drgoňa
6/23/2016	1.8	Correction of examples for data flow E-07_01 and E-07_02. Removal of the element <i>Period</i> from ISOTEDATA-VDT messages.	Ing. Jozef Drgoňa
9/5/2017	1.9	Addition of service specification for broader communication possibilities like managing intraday market orders, results of intraday market and automated notifications about events on intraday market using AMQP protocol.	Ing. Robert Maier
10/1/2018	1.10	Expansion of existing data flows E-06_03 and E-10_01, which contains anonymous user identifier of the user placing intraday market order.	Ing. Robert Maier
11/2/2020	1.11	Update of network TLS protocol support.	Ing. Robert Maier

Date	Version	Description	Author
01/24/2021	1.12	Extension of day-ahead market products with possibility to submit unlimited number of orders per MP and introduction of new simple block, linked block, flexible block products and exclusive group of block orders.	Ing. Robert Maier
04/30/2021	1.13	Extension of DAM evaluation with the parameter for specification of result status.	Ing. Robert Maier
03/02/2022	1.14	Disabling of access to cross-border capacities for CORE regime of cross-border day-ahead market.	Ing. Robert Maier
09/27/2022	1.15	Extension of external interfaces for intraday market according to products extension and creation of cross-border intraday market within the SIDC project.	Ing. Robert Maier
01/17/2024	1.16	Extension of IDM data flows by trading screen statistics in extent: <ul style="list-style-type: none"> • Last price/quantity traded in the trading period, • Overall traded quantity within the period. 	Ing. Robert Maier
03/22/2024	1.17	Extension of external interfaces for communication of market participants within the intraday auctions (IDAs).	Ing. Robert Maier
07/10/2024	1.18	New SANDBOX environment https://sandbox-isot.okte.sk available for market participants.	Ing. Robert Maier

1 INTRODUCTION

1.1 Characteristics of the document

1.1.1 Purpose of the document

The purpose of this document is to provide all necessary technical information for the implementation of automated data exchange between an external system of a market participant and the market organizer information system XMtrade®/ISOT. This document contains specification of communication methods and data structures that are used for data exchange.

1.1.2 Specification of the document

The document is for system implementers who are preparing integration with the market organizer information system XMtrade®/ISOT.

2 OVERVIEW OF EXTERNAL INTERFACES

The market organizer information system XMtrade®/ISOT provides automated interfaces for data exchange within processes of the day-ahead, intraday continuous and intraday auction order registration, and results and evaluations retrieval of day-ahead market based on web services that are used by trading systems of market participants.

Table 1 Automated interface for data exchange of processes within day-ahead order registration

ID	Name	Description
OB-01	Management of market participant orders	Market participants are provided with an automated interface for submission and retrieval of own orders for purchase and sell on day-ahead market.
OB-02	Management of intraday market participant orders	Market participants are provided with an automated interface for submission, modification and retrieval of own orders for purchase and sell on intraday market.
OB-03	Access to intraday market order book	Market participants are provided with automated interface for intraday order book retrieval in its current status and available cross-border capacities.
OB-04	Management of market participant orders for intraday auctions	Market participants are provided with an automated interface for submission and retrieval of own orders for purchase and sell on intraday auctions.
EV-01	Results and evaluation of DM	Market participants are provided with automated interface for day-ahead market results and evaluations retrieval.
EV-02	Results of IDM	Market participants are provided with automated interface for intraday market results and evaluations retrieval.
EV-03	Results and evaluation of IDA	Market participants are provided with automated interface for intraday auctions results and evaluations retrieval.
SR-01	MCC details	Market participants are provided with an automated interface for MCC values retrieval.
AMQP-01	Notifications of IDM	Market participants are provided with an automated interface for automatic notifications about their own intraday orders, data from intraday order book and change of available cross-border capacities within intraday market.

2.1 Overview of data flows

Basic communication scenarios are primarily dependent on the task that the market organizer currently performs:

- organizing of day-ahead market exclusively within domestic trading area,
- coordinated organizing of day-ahead market in multiple trading areas.
- organizing of intraday market exclusively within domestic trading area,
- coordinated organizing of intraday auctions within several trading areas.

2.1.1 Organization of domestic day-ahead market

Within the organization of domestic short-term day-ahead market, communication is established between the market organizer information system XMtrade®/ISOT, (ISOT) and systems of market participants (ISMP) through web services (Figure 1). Using automated method, market participants are able to submit orders into the PXS system, retrieve results and evaluations of day-ahead market.

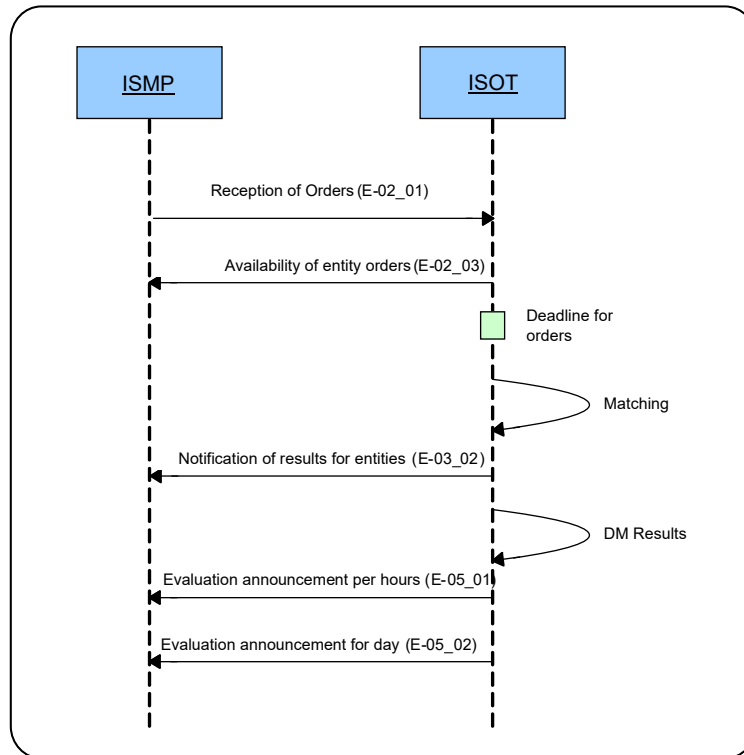

Figure 1 Communication scenario in domestic day-ahead market mode

Table 2 Overview of interfaces in domestic day-ahead market mode

ID	Description	Source	Target	Initiator
E-02_01	Reception of orders: - allows market participant to submit orders by the deadline for order reception.	ISMP	ISOT	ISMP
E-02_03	Availability of entity orders: - allows market participant to retrieve information on own orders entered into ISOT.	ISOT	ISMP	ISMP
E-03_02	Notification of results for entities: - allows market participant to retrieve information on DM results after order matching is finished.	ISOT	ISMP	ISMP
E-05_01	Evaluation announcement per hours: - allows market participant to retrieve detailed information on DM evaluation after the end of DM matching.	ISOT	ISMP	ISMP
E-05_02	Evaluation announcement for day: - allows market participant to retrieve summary information on DM evaluation after the end of DM matching.	ISOT	ISMP	ISMP

2.1.2 Coordinated organization of day-ahead market

Within the coordinated organization of short-term day-ahead market, communication is established between the market organizer information system XMtrade®/ISOT (ISOT) and systems of market participants (ISMP) through web services (Figure 2). Information on MCC results, evaluations of day-ahead market and market participants orders entered into ISOT system, are made available through an automated method.

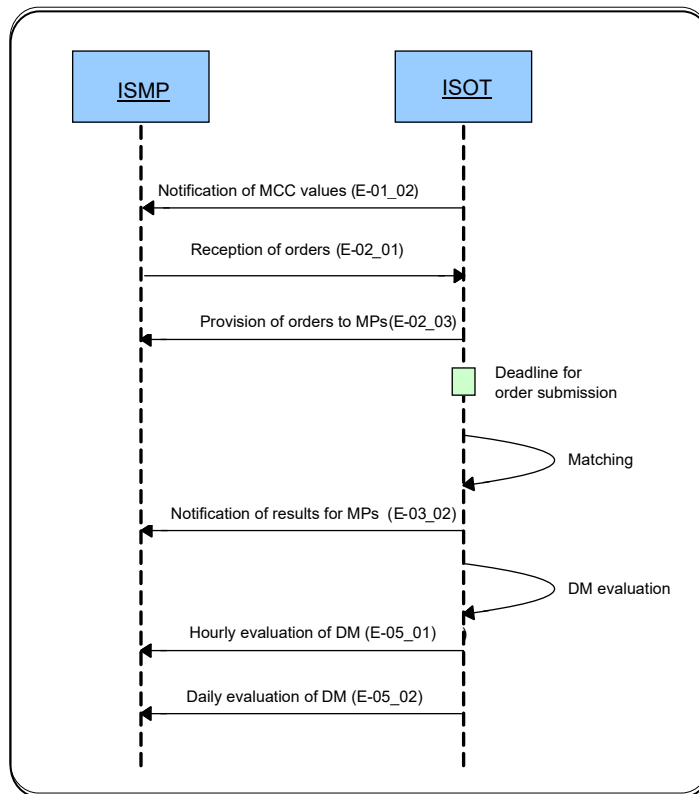

Figure 2 Communication scenario in coordinated day-ahead market mode

Table 3 Overview of interfaces in day-ahead market mode

ID	Description	Source	Target	Initiator
E-01_02	Notification of MCC values: - allows market participant to retrieve information on MCC after the publication of MCC.	ISOT	ISMP	ISMP
E-02_01	Reception of orders: - allows market participant to submit orders by the deadline for order reception.	ISMP	ISOT	ISMP
E-02_03	Availability of entity orders: - allows market participant to retrieve information on own orders entered into ISOT.	ISOT	ISMP	ISMP
E-03_02	DM evaluation announcement for entities: - allows market participant to retrieve information on DM results after the end of matching.	ISOT	ISMP	ISMP
E-05_01	DM evaluation announcement per hours: - allows market participant to retrieve detailed information on DM evaluation after the end of DM matching.	ISOT	ISMP	ISMP
E-05_02	DM evaluation announcement for day: - allows market participant to retrieve summary information on DM evaluation after the end of DM matching.	ISOT	ISMP	ISMP

2.1.3 Organizing domestic intraday market

Within the organization of domestic intraday market, communication is established between the market organizer information system XMtrade®/ISOT (ISOT), and systems of market participants (ISMP) through web services (Figure 3) and through interface based on AMQP communication protocol (Figure 4). Using automated methods, market participants submit orders into the ISOT system and receive related results and evaluations of intraday market and using the AMQP protocol, notifications about change of current market status are distributed to market participants.

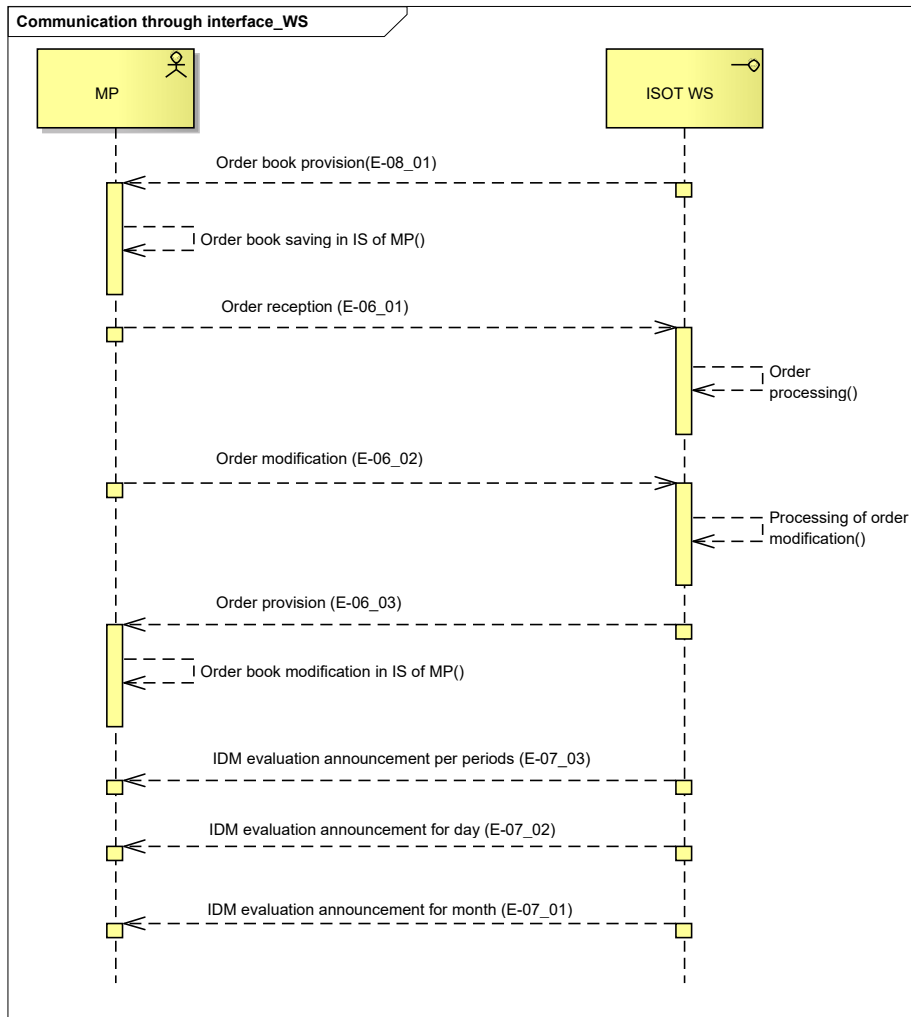

Figure 3 Communication scenario of the web services in domestic intraday market mode

Table 4 Overview of interfaces in domestic intraday market mode

ID	Description	Source	Target	Initiator
E-06_01	Reception of intraday orders: - allows market participant to submit orders until the gate closure order reception.	ISMP	ISOT	ISMP
E-06_02	Modification of intraday orders: - allows market participant to modify (activate, deactivate, cancel) own existing order.	ISMP	ISOT	ISMP

ID	Description	Source	Target	Initiator
E-06_03	Availability of intraday entity orders: - allows market participant to retrieve information on own orders entered into ISOT.	ISOT	ISMP	ISMP
E-07_01	IDM evaluation announcement for day: - allows market participant to access information about intraday evaluation after trading day closure and after intraday evaluation is finished.	ISOT	ISMP	ISMP
E-07_02	IDM evaluation announcement for month: - allows market participant to access information about intraday evaluation after trading month closure and after intraday per given month evaluation is finished.	ISOT	ISMP	ISMP
E-07_03	IDM evaluation announcement per periods: - allows market participant to access information about their intraday orders per periods.	ISOT	ISMP	ISMP
E-08_01	Order book provision: - allows market participant to access immediate data from order book (available quantities and prices) on intraday market.	ISOT	ISMP	ISMP

Web services described above are intended for full automation of communication with ISOT system, which includes interface extension that uses AMQP protocol and allows market participant to receive notifications about real-time changes on IDM.

Through notifications, market participant is informed about these events:

- Successful creation of own order,
- Modification of own order (change of status),
- Order book status change (increase/decrease of available quantity).

Table 5 Overview of AMPQ interface in domestic intraday market mode

ID	Description	Source	Target	Initiator
E-10_01	Change of status/creation of own order: - informs market participant about successful creation or modification of own order.	ISMP	ISOT	ISOT
E-10_02	Order book status change: - informs market participant about change in order book status (increase/decrease of available quantity).	ISMP	ISOT	ISOT

2.1.4 Coordinated organization of intraday market

Within the coordinated organization of intraday market, communication is established between the market organizer information system XMtrade®/ISOT (ISOT), and systems of market participants (ISMP) through web services (Figure 5) and through interface based on AMQP communication protocol (Figure 6). Using automated methods, market participants submit orders into the ISOT system and receive related results and evaluations of intraday market and using the AMQP protocol, notifications about change of current market status and available cross-border capacities are distributed to market participants.

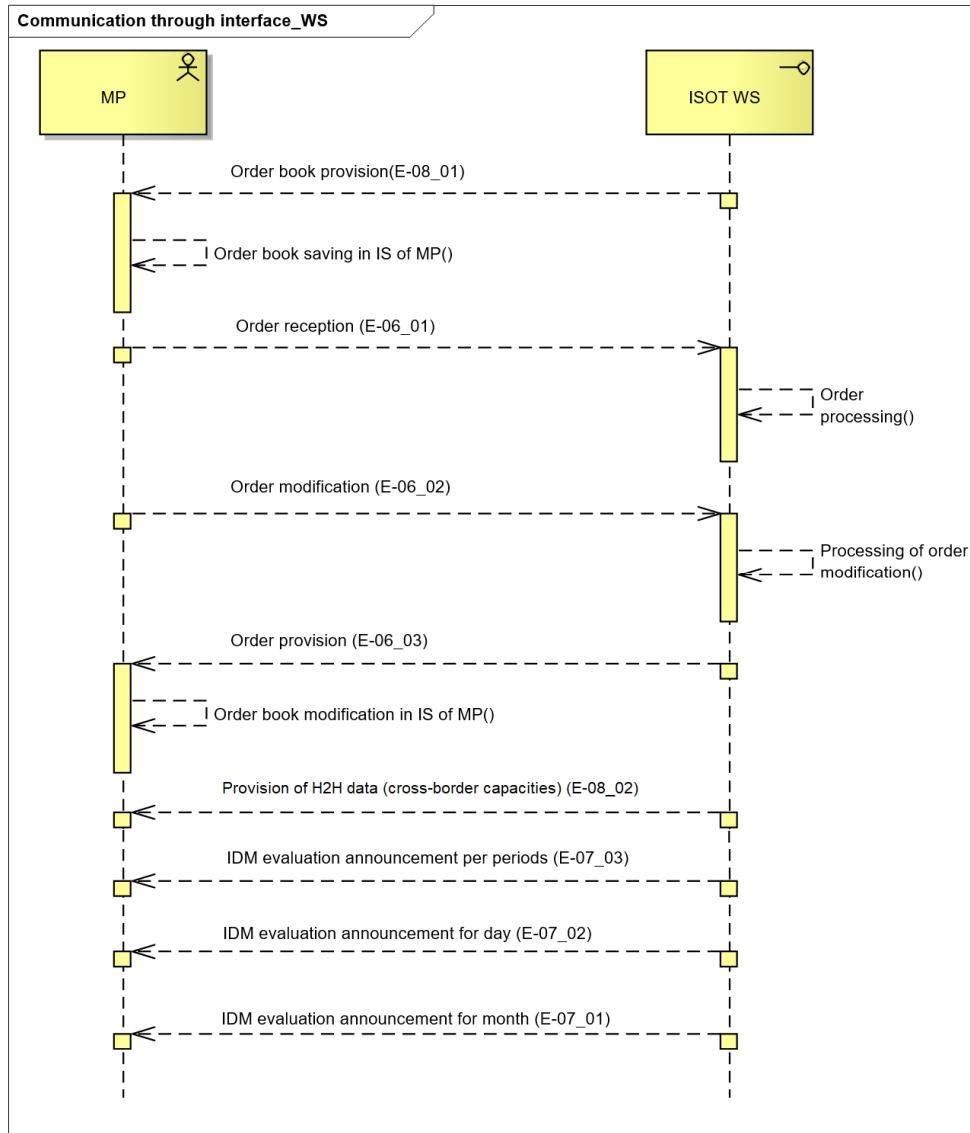

Figure 5 Communication scenario of the web services in coordinated intraday market mode

Table 6 Overview of interfaces in coordinated intraday market mode

ID	Description	Source	Target	Initiator
E-06_01	Reception of intraday orders: - allows market participant to submit orders until the gate closure order reception.	ISMP	ISOT	ISMP

ID	Description	Source	Target	Initiator
E-06_02	Modification of intraday orders: - allows market participant to modify (activate, deactivate, cancel) own existing order.	ISMP	ISOT	ISMP
E-06_03	Availability of intraday entity orders: - allows market participant to retrieve information on own orders entered into ISOT.	ISOT	ISMP	ISMP
E-07_01	IDM evaluation announcement for day: - allows market participant to access information about intraday evaluation after trading day closure and after intraday evaluation is finished.	ISOT	ISMP	ISMP
E-07_02	IDM evaluation announcement for month: - allows market participant to access information about intraday evaluation after trading month closure and after intraday per given month evaluation is finished.	ISOT	ISMP	ISMP
E-07_03	IDM evaluation announcement per periods: - allows market participant to access information about their intraday orders per periods.	ISOT	ISMP	ISMP
E-08_01	Order book provision: - allows market participant to access immediate data from order book (available quantities and prices) on intraday market.	ISOT	ISMP	ISMP
E-08_02	Provision of Hub-to-Hub matrix (H2H) data with information about available cross-border capacities: - allows market participant to access information about available cross-border capacities between SK market area and other delivery areas within SIDC. This information serves for informative purposes only and its provision can be subject to delay against the real state within the central system for matching of intraday market orders within SIDC.	ISOT	ISMP	ISMP

Web services described above are intended for full automation of communication with ISOT system, which includes interface extension that uses AMQP protocol and allows market participant to receive notifications about real-time changes on IDM.

Through notifications, market participant is informed about these events:

- Successful creation of own order,
- Modification of own order (change of status),
- Order book status change (increase/decrease of available quantity),
- Change of available cross-border capacities.

Table 7 Overview of AMPQ interface in coordinated intraday market mode

ID	Description	Source	Target	Initiator
----	-------------	--------	--------	-----------

E-10_01	Change of status/creation of own order: - informs market participant about successful creation or modification of own order.	ISMP	ISOT	ISOT
E-10_02	Order book status change: - informs market participant about change in order book status (increase/decrease of available quantity).	ISMP	ISOT	ISOT
E-10_03	Change in Hub-to-Hub matrix (H2H) data with information about available cross-border capacities: - informs market participant about a change in Hub-to-Hub matrix data containing available cross-border capacities between SK market area and other delivery areas within SIDC. This information serves for informative purposes only and its provision can be subject to delay against the real state within the central system for matching of intraday market orders within SIDC.	ISMP	ISOT	ISOT

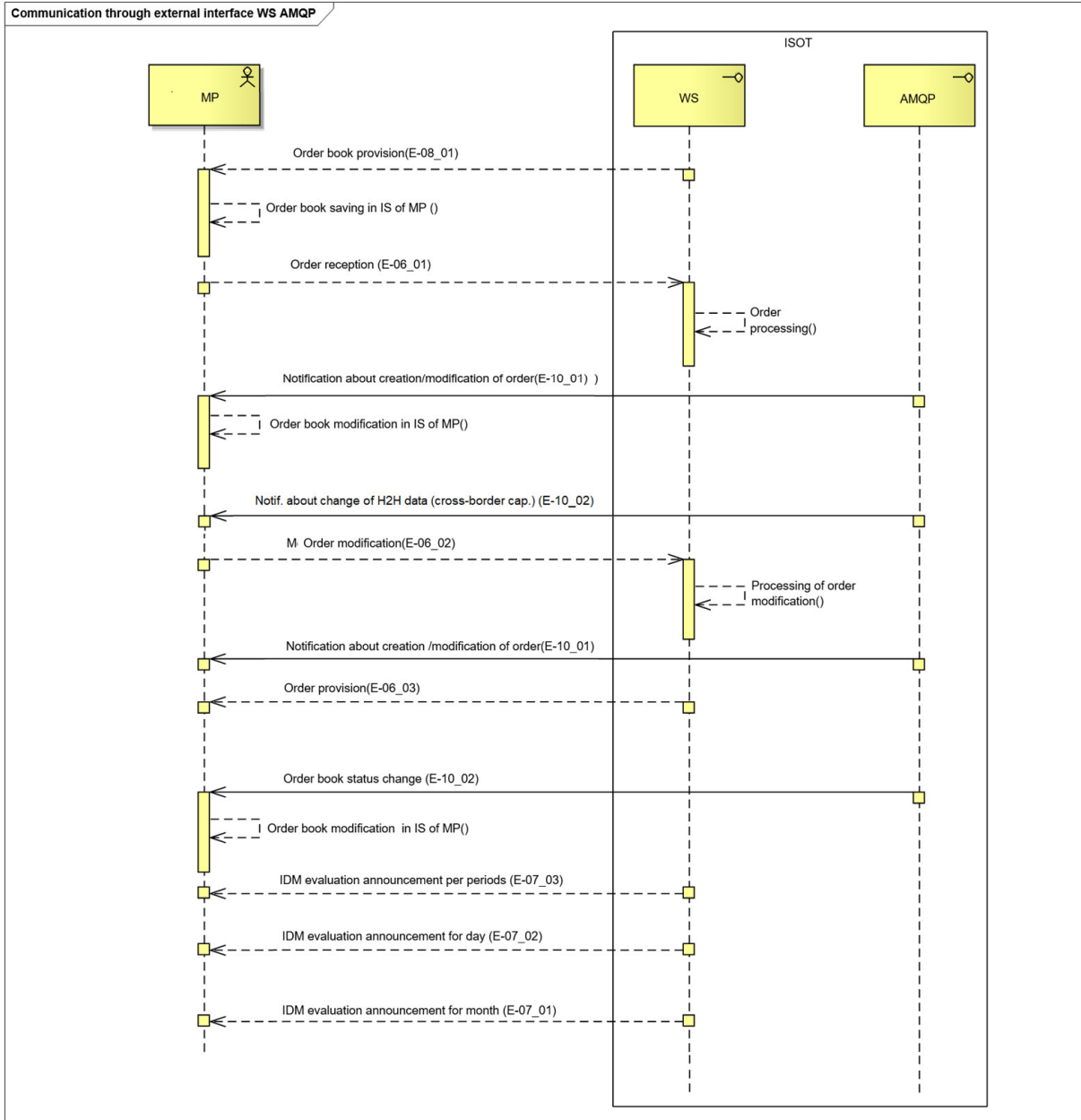

Figure 6 Communication scenario of web services and AMQP interface in coordinated intraday market mode

2.1.5 Coordinated organization of intraday auctions

Within the coordinated organization of intraday auctions, communication is established between the market organizer information system XMtrade®/ISOT (ISOT) and systems of market participants (ISMP) through web services (Figure 7). Information on relevant auction results, evaluations of auctions and market participants orders entered into ISOT system, are made available through an automated method.

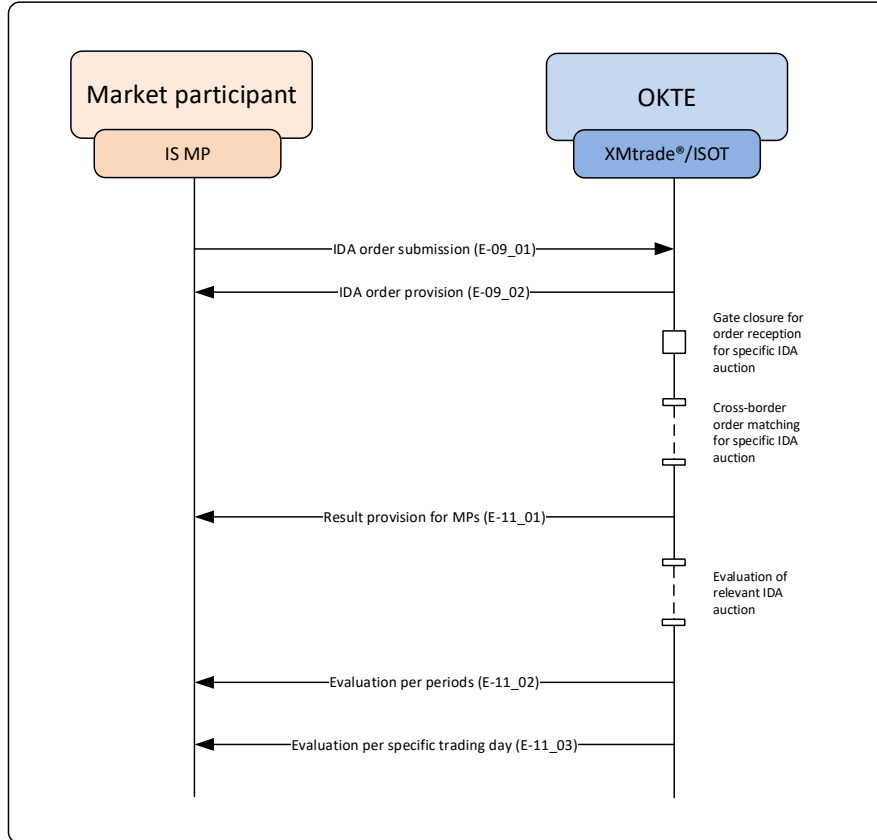

Figure 7 Communication scenario in coordinated organization of intraday auctions

Table 8 Overview of interfaces in intraday auctions mode

ID	Opis	Zdroj	Ciel'	Iniciátor
E-09_01	Reception of IDA orders: - allows market participant to submit orders by the deadline for order reception for specific intraday auction.	ISÚT	ISOT	ISÚT
E-09_02	Provision of IDA orders for market participants: - allows market participant to retrieve information on own orders entered into ISOT for specific intraday auction.	ISOT	ISÚT	ISÚT
E-11_01	IDA evaluation announcement for market participants: - allows market participant to retrieve information on DM results after matching of specific intraday auction.	ISOT	ISÚT	ISÚT
E-11_02	IDA evaluation announcement per hours: - allows market participant to retrieve detailed information on IDA evaluation after matching of specific intraday auction.	ISOT	ISÚT	ISÚT
E-11_03	ODA evaluation announcement for day: - allows market participant to retrieve summary information on IDA evaluation after matching of specific intraday auction.	ISOT	ISÚT	IS ÚT

3 SPECIFICATION OF COMMUNICATION

3.1 Web services

The market organizer information system XMtrade®/ISOT covers external interfaces with the following set of web services/web methods.

Table 9 Overview of interfaces in the coordinated organization of day-ahead and intraday market mode

ID	Name of web service	Name of web method	Description
OB-01	Orders	Upload Download	-market participants are provided with automated interface for submission and reception of own orders on day-ahead market
OB-02	IdmOrders	Upload Modify Download	-market participants are provided with automated interface for submission, modification and reception of own orders on intraday market
OB-03	IdmOrderBook	Download	- market participants are provided with automated interface for downloading intraday order book data and available cross-border capacities
OB-04	IdaOrders	Upload Download	- market participants are provided with automated interface for submission and reception of own orders on intraday auctions
EV-01	Evaluations	Download	- market participants are provided with automated interface for retrieval of results/evaluations of day-ahead market
EV-02	IdmEvaluations	Download	- market participants are provided with automated interface for retrieval of results/evaluations of intraday market
EV-03	IdaEvaluations	Download	- market participants are provided with automated interface for retrieval of results/evaluations of intraday auctions
SR-01	StatusRequest	DownloadMCC	- market participants are provided with automated interface for retrieval of MCC values

3.1.1 Communication scenarios

Synchronous communication

Synchronous communication of web services in ISOT system can be in general depicted as follows:

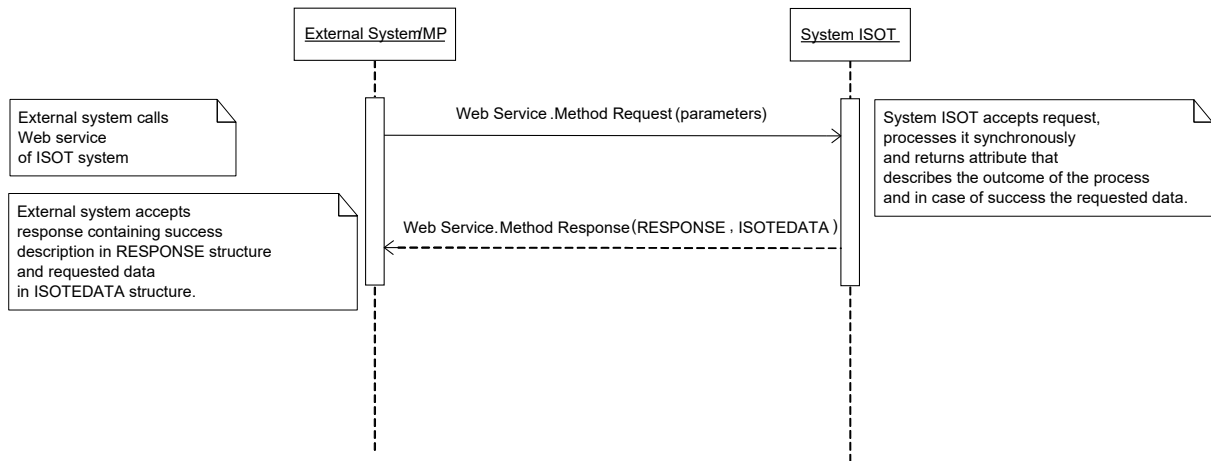

Figure 8 The principle of synchronous communication.

Synchronous call of web method processes the request and returns corresponding response.

3.1.2 SOAP Protocol

The structure of SOAP messages is implemented in SOAP 1.2 version in accordance with recommendations of W3C consortium (<http://www.w3.org/TR/soap12>) and uses the following extensions:

- WS-Security (<http://www.oasis-open.org/specs/index.php#wssv1.0>),
- WS-Addressing (<http://www.w3.org/Submission/2004/SUBM-ws-addressing-20040810>).

In order to shorten the notation of individual SOAP messages, the following namespace aliases are used:

Table 10 Namespace aliases

Alias	Namespace
s	http://www.w3.org/2003/05/soap-envelope
o	http://docs.oasis-open.org/wss/2004/01/oasis-200401-wss-wssecurity-secext-1.0.xsd
a	http://schemas.xmlsoap.org/ws/2004/08/addressing
u	http://docs.oasis-open.org/wss/2004/01/oasis-200401-wss-wssecurity-utility-1.0.xsd

Web services are implemented in the namespace of the following format:

<http://sfera.sk/ws/xmtrade/isot/interfaces/NameOfService/services/Version>

SOAP messages of systems web services contain two distinctive parts: header and body, while all messages of ISOT system are encoded in UTF-8. In addition to controlling data of the protocol, header contains details for authentication and authorization of the calling system (name, password and digital signature if applicable).

```

<s:Header>
  <!-- WS-Addressing -->
  <!-- WS-Security -->
</s:Header>
  
```

„WS-Security " contains security tokens necessary for source system authentication and verification of message integrity. This relates to electronic signature tokens, name and password of a user.

„WS-Addressing " contains details to secure addressing of a soap message. Detailed header structure can be found in this example.

Message body contains class element of the message for specific request. Body structure of the message can be defined in general as follows:

Request:

```
<s:Body>
  <MethodNameRequest xmlns=" http://sfera.sk/ws/xmtrade/isot/interfaces/
  NameOfService/services/Version">
    <!--message document-->
  </MethodNameRequest>
</s:Body>
```

Response:

```
<s:Body>
  <MethodNameResponse xmlns="http://sfera.sk/ws/xmtrade/isot/interfaces/
  NameOfService/services/Version">
    <!--message document -->
  </MethodNameResponse>
</s:Body>
```

SOAP Fault

SOAP Fault element serves for generic transfer of error information, which are transferred within SOAP message in `<s:Fault>` element, in accordance with SOAP 1.2 specification (<http://www.w3.org/TR/soap12-part1/#soapfault>). It mainly relates to system error and exception handling during communication etc. However, defining custom types of Fault messages could be advantageously used to catch general application errors.

3.1.3 Orders

Orders web service allows market participants to use automated interface for submission and reception of own orders on day-ahead market.

The service implements the following methods:

- *Upload* – method for submission of order,
- *Download* – method for reception of own order.

SOAP Upload

Upload method of *Orders* service operates in synchronous mode, i.e. the request is handled by the response within the same call.

Description of request structure

Table 11 Request structure description – Upload method

UploadRequest	Description
ISOTEDATA	Structure of order is in accordance with specification where message-code=811 (see description of E-02_01 data flow).

Description of response structure

Table 12 Response structure description - Upload method

UploadResponse	Description
RESPONSE	Common return structure of request handling effectivity is in accordance with specification where message-code=812 (see description of data flow E-02_01).
ISOTEDATA	Structure of order is in accordance with specification where message-code=813 (see description data flow E-02_01). Description of order is returned as it was registered in the system.

Example of SOAP message

Request:

```

POST /Orders.WCF.Host/ServiceReference.svc HTTP/1.1
Content-Type: application/soap+xml; charset=utf-8
Host: ...
Content-Length: ...
Expect: 100-continue
Connection: Keep-Alive

<s:Envelope xmlns:s="http://www.w3.org/2003/05/soap-envelope"
xmlns:u="http://docs.oasis-open.org/wss/2004/01/oasis-200401-wss-wssecurity-utility-
1.0.xsd">
  <s:Header>
    <!-- WS-Addressing -->
    <!-- WS-Security -->
  </s:Header>
  <s:Body u:Id="_1">
    <ns:UploadRequest
xmlns:ns="http://sfera.sk/ws/xmtrade/isot/interfaces/orders/services/2009/04/01">
      <ns:ISOTEDATA
xmlns="http://sfera.sk/ws/xmtrade/isot/interfaces/orders/types/2009/04/01" id="1"
message-code="811" date-time="2009-05-01T11:48:51" answer-required="1">
        <!-- order data -->
      </ns:ISOTEDATA>
    </ns:UploadRequest>
  </s:Body>
</s:Envelope>

```

Response:

```

HTTP/1.1 200 OK
Server: ASP.NET Development Server/9.0.0.0
Date: Sun, 30 Nov 2008 16:58:25 GMT
X-AspNet-Version: 2.0.50727
Cache-Control: private
Content-Type: application/soap+xml; charset=utf-8
Content-Length: ...
Connection: Close

<s:Envelope xmlns:s="http://www.w3.org/2003/05/soap-envelope"
xmlns:u="http://docs.oasis-open.org/wss/2004/01/oasis-200401-wss-wssecurity-
utility-1.0.xsd">
  <s:Header>
    <!-- WS-Addressing -->
    <!-- WS-Security -->
  </s:Header>
  <s:Body u:Id="_1">
    <ns:UploadResponse
xmlns:ns="http://sfera.sk/ws/xmtrade/isot/interfaces/orders/services/2009/04/01">
      <ns:RESPONSE xmlns="http://sfera.sk/ws/xmtrade/isot/ut/types/2009/04/01"
message-code="812" ...>
        <!-- efficiency description -->
      </ns:RESPONSE>
      <ns:ISOTEDATA
xmlns="http://sfera.sk/ws/xmtrade/isot/interfaces/orders/types/2009/04/01"
message-code="813" ...>
        <!-- order description data -->
      </ns:ISOTEDATA>
    </ns:UploadResponse>
  </s:Body>
</s:Envelope>

```

SOAP Download

Download method of Orders service operates in synchronous mode, i.e. the request is handled by the response within the same call.

Description of request structure

Table 13 Request structure description – Download method

DownloadRequest	Description
CDSREQ	Request structure for reception of own order in accordance with specification , where message-code=831 (see description of E-02_03 data flow).

Description of response structure

Table 14 Response structure description – Download method

DownloadResponse	Description
RESPONSE	Common return structure of request handling effectivity in accordance with specification, where message-code=832 (see description of E-02_03 data flow).
ISOTEDATA	Structure of order in accordance with specification , where message-code=833 (see description of E-02_03 data flow). Description of order is returned as it was registered in the system.

Example of SOAP message

Request:

```
POST /Orders.WCF.Host/ServiceReference.svc HTTP/1.1
Content-Type:application/soap+xml; charset=utf-8
Host: ...
Content-Length: ...
Expect: 100-continue
Connection: Keep-Alive

<s:Envelope xmlns:s="http://www.w3.org/2003/05/soap-envelope"
xmlns:u="http://docs.oasis-open.org/wss/2004/01/oasis-200401-wss-wssecurity-
utility-1.0.xsd">
  <s:Header>
    <!-- WS-Addressing -->
    <!-- WS-Security -->
  </s:Header>
  <s:Body u:Id="_1">
    <ns:DownloadRequest
xmlns:ns="http://sfera.sk/ws/xmtrade/isot/interfaces/orders/services/2009/04/01">
      <ns:CDSREQ
xmlns="http://sfera.sk/ws/xmtrade/isot/interfaces/ut/types/2009/04/01" id="1"
message-code="831" date-time="2009-05-01T11:48:51" >
        <Trade trade-day="2009-05-01" />
      </ns:CDSREQ>
    </ns:DownloadRequest>
  </s:Body>
</s:Envelope>
```

Response:

```

HTTP/1.1 200 OK
Server: ASP.NET Development Server/9.0.0.0
Date: Sun, 30 Nov 2008 16:58:25 GMT
X-AspNet-Version: 2.0.50727
Cache-Control: private
Content-Type: application/soap+xml; charset=utf-8
Content-Length: ...
Connection: Close

<s:Envelope xmlns:s="http://www.w3.org/2003/05/soap-envelope"
xmlns:u="http://docs.oasis-open.org/wss/2004/01/oasis-200401-wss-wssecurity-
utility-1.0.xsd">
  <s:Header>
    <!-- WS-Addressing -->
    <!-- WS-Security -->
  </s:Header>
  <s:Body u:Id="_1">
    <ns:DownloadResponse
xmlns:ns="http://sfera.sk/ws/xmtrade/isot/interfaces/orders/services/2009/04/01">
      <ns:RESPONSE xmlns="http://sfera.sk/ws/xmtrade/isot/ut/types/2009/04/01"
message-code="832" ... >
        <!-- description of efficiency -->
      </ns:RESPONSE>
      <ns:ISOTEDATA
xmlns="http://sfera.sk/ws/xmtrade/isot/interfaces/orders/types/2009/04/01"
message-code="833" ... >
        <!-- description of order data -->
      </ns:ISOTEDATA>
    </ns:DownloadResponse>
  </s:Body>
</s:Envelope>

```

3.1.4 IdmOrders

IdmOrders web service allows market participants to use automated interface for submission, modification and reception of own orders on intraday market.

Service implements these methods:

- *Upload* - method for order submission,
- *Modify* – method for order modification (activation/deactivation/cancellation),
- *Download* – method for own order reception.

SOAP Upload

Upload method of *IdmOrders* service operates in synchronous mode, i.e. the request is handled by the response within the same call. Response to this request consists of confirmation of order submission and copy of order data from the request.

Description or request structure

Table 15 Request structure description – Upload method

UploadRequest	Description
ISOTEDATA-VDT	Structure of order is in accordance with specification , where message-code=801 (see description of E-06_01 data flow).

Description of request structure

Table 16 Response structure description - Upload method

UploadResponse	Description
RESPONSE-VDT	Common structure of retrieving processing status is in accordance with specification, where message-code=802 (see description of E-06_01 data flow).
ISOTEDATA-VDT	Structure of order is in accordance with specification , where message-code=803 (see description of E-06_01 data flow). Returned order data sent in request.

Example of SOAP message

Request:

```
POST /IdmOrders.WCF.Host/ServiceReference.svc HTTP/1.1
Content-Type:application/soap+xml; charset=utf-8
Host: ...
Content-Length: ...
Expect: 100-continue
Connection: Keep-Alive

<s:Envelope xmlns:s="http://www.w3.org/2003/05/soap-envelope"
xmlns:u="http://docs.oasis-open.org/wss/2004/01/oasis-200401-wss-wssecurity-
utility-1.0.xsd">
  <s:Header>
    <!-- WS-Addressing -->
    <!-- WS-Security -->
  </s:Header>
  <s:Body u:Id="_1">
    <ns:UploadRequest
xmlns:ns="http://sfera.sk/ws/xmtrade/isot/interfaces/idmorders/services/2009/04/0
1">
      <ns:ISOTEDATA xmlns="http://sfera.sk/xmtrade/isot/types/IDM/2016/04/01"
id="1" message-code="801" date-time="2016-05-01T11:48:51" answer-required="1">
        <!-- order data -->
      </ns:ISOTEDATA>
    </ns:UploadRequest>
  </s:Body>
</s:Envelope>
```

Response:

```

HTTP/1.1 200 OK
Server: ASP.NET Development Server/9.0.0.0
Date: Sun, 30 Nov 2016 16:58:25 GMT
X-AspNet-Version: 2.0.50727
Cache-Control: private
Content-Type: application/soap+xml; charset=utf-8
Content-Length: ...
Connection: Close

<s:Envelope xmlns:s="http://www.w3.org/2003/05/soap-envelope"
xmlns:u="http://docs.oasis-open.org/wss/2004/01/oasis-200401-wss-wssecurity-
utility-1.0.xsd">
  <s:Header>
    <!-- WS-Addressing -->
    <!-- WS-Security -->
  </s:Header>
  <s:Body u:Id="_1">
    <ns:UploadResponse
xmlns:ns="http://sfera.sk/ws/xmtrade/isot/interfaces/idmorders/services/2016/04/0
1">
      <ns:RESPONSE xmlns="http://sfera.sk/ws/xmtrade/isot/ut/types/2009/04/01"
message-code="802" ...>
        <!--success description -->
      </ns:RESPONSE>
      <ns:ISOTEDATA xmlns="http://sfera.sk/xmtrade/isot/types/IDM/2016/04/01"
message-code="803" ...>
        <!--order data description -->
      </ns:ISOTEDATA>
    </ns:UploadResponse>
  </s:Body>
</s:Envelope>

```

SOAP Modify

Modify method of *IdmOrders* web service operates in synchronous mode, i.e. the request is handled by the response within the same call. Response to this request consists of order modification processing status and order modification data copy from the request.

*Description of request structure***Table 17** Request structure description – Method Modify

UploadRequest	Description
ISOTEDATA-VDT	Structure of order is in accordance with specification , where message-code=804 (see description of E-06_02 data flow).

*Description of response structure***Table 18** Response structure description – Method Modify

UploadResponse	Description
RESPONSE-VDT	Common structure of retrieving processing status is in accordance with specification , where message-code=805 (see description of E-06_02 data flow).
ISOTEDATA-VDT	Structure of order is in accordance with specification , where message-code=806 (see description of E-06_02 data flow). Response includes modification description sent in the request.

Example of SOAP messages

Request:

```

POST /IdmOrders.WCF.Host/ServiceReference.svc HTTP/1.1
Content-Type:application/soap+xml; charset=utf-8
Host: ...
Content-Length: ...
Expect: 100-continue
Connection: Keep-Alive

<s:Envelope xmlns:s="http://www.w3.org/2003/05/soap-envelope"
xmlns:u="http://docs.oasis-open.org/wss/2004/01/oasis-200401-wss-wssecurity-
utility-1.0.xsd">
  <s:Header>
    <!-- WS-Addressing -->
    <!-- WS-Security -->
  </s:Header>
  <s:Body u:Id="_1">
    <ns:UploadRequest
xmlns:ns="http://sfera.sk/ws/xmtrade/isot/interfaces/idmorders/services/2009/04/0
1">
      <ns:ISOTEDATA xmlns="http://sfera.sk/xmtrade/isot/types/IDM/2016/04/01"
id="1" message-code="804" date-time="2016-05-01T11:48:51" answer-required="1">
        <!-- data of order modification-->
      </ns:ISOTEDATA>
    </ns:UploadRequest>
  </s:Body>
</s:Envelope>

```

Response:

```

HTTP/1.1 200 OK
Server: ASP.NET Development Server/9.0.0.0
Date: Sun, 30 Nov 2016 16:58:25 GMT
X-AspNet-Version: 2.0.50727
Cache-Control: private
Content-Type: application/soap+xml; charset=utf-8
Content-Length: ...
Connection: Close

<s:Envelope xmlns:s="http://www.w3.org/2003/05/soap-envelope"
xmlns:u="http://docs.oasis-open.org/wss/2004/01/oasis-200401-wss-wssecurity-
utility-1.0.xsd">
  <s:Header>
    <!-- WS-Addressing -->
    <!-- WS-Security -->
  </s:Header>
  <s:Body u:Id="_1">
    <ns:UploadResponse
xmlns:ns="http://sfera.sk/ws/xmtrade/isot/interfaces/idmorders/services/2016/04/0
1">
      <ns:RESPONSE xmlns="http://sfera.sk/ws/xmtrade/isot/ut/types/2009/04/01"
message-code="805" ...>
        <!-- processing status description-->
      </ns:RESPONSE>
      <ns:ISOTEDATA xmlns="http://sfera.sk/xmtrade/isot/types/IDM/2016/04/01"
message-code="806" ...>
        <!-- order description -->
      </ns:ISOTEDATA>
    </ns:UploadResponse>
  </s:Body>
</s:Envelope>

```

SOAP Download

Download method of *IdmOrders* web service operates in synchronous mode, i.e. the request is handled by the response within the same call. Response to request for order submission consists of request processing status and data of chosen order or all orders within a specified time interval.

Description of request structure

Table 19 Request structure description – Method Download

UploadRequest	Description
CDSREQ-VDT	Order structure is in accordance with specification , where message-code=807 (see description of E-06_03 data flow).

Description of response structure

Table 20 Response structure description - Method Download

UploadResponse	Description
RESPONSE-VDT	Common structure of retrieving processing status is in accordance with specification , where message-code=808 (see description of E-06_03 data flow).
ISOTEDATA-VDT	Structure of order is in accordance with specification , where message-code=809 (see description of E-06_03 data flow). Returned data contains information about specific order or all orders in specified time interval depending on request formulation.

Example of SOAP messages

Request:

```
POST /IdmOrders.WCF.Host/ServiceReference.svc HTTP/1.1
Content-Type: application/soap+xml; charset=utf-8
Host: ...
Content-Length: ...
Expect: 100-continue
Connection: Keep-Alive

<s:Envelope xmlns:s="http://www.w3.org/2003/05/soap-envelope"
xmlns:u="http://docs.oasis-open.org/wss/2004/01/oasis-200401-wss-wssecurity-
utility-1.0.xsd">
  <s:Header>
    <!-- WS-Addressing -->
    <!-- WS-Security -->
  </s:Header>
  <s:Body u:Id="_1">
    <ns:UploadRequest
xmlns:ns="http://sfera.sk/ws/xmtrade/isot/interfaces/idmorders/services/2009/04/0
1">
      <ns:CDSREQ xmlns="http://sfera.sk/xmtrade/isot/types/IDM/2016/04/01" id="1"
message-code="807" date-time="2016-05-01T11:48:51" answer-required="1">
        <!-- data from order modification -->
      </ns:CDSREQ>
    </ns:UploadRequest>
  </s:Body>
</s:Envelope>
```

Response:

```

HTTP/1.1 200 OK
Server: ASP.NET Development Server/9.0.0.0
Date: Sun, 30 Nov 2016 16:58:25 GMT
X-AspNet-Version: 2.0.50727
Cache-Control: private
Content-Type: application/soap+xml; charset=utf-8
Content-Length: ...
Connection: Close

<s:Envelope xmlns:s="http://www.w3.org/2003/05/soap-envelope"
xmlns:u="http://docs.oasis-open.org/wss/2004/01/oasis-200401-wss-wssecurity-
utility-1.0.xsd">
  <s:Header>
    <!-- WS-Addressing -->
    <!-- WS-Security -->
  </s:Header>
  <s:Body u:Id="_1">
    <ns:UploadResponse
xmlns:ns="http://sfera.sk/ws/xmtrade/isot/interfaces/idmorders/services/2016/04/0
1">
      <ns:RESPONSE xmlns="http://sfera.sk/ws/xmtrade/isot/ut/types/2009/04/01"
message-code="808" ...>
        <!-- processing status description -->
      </ns:RESPONSE>
      <ns:ISOTEDATA xmlns="http://sfera.sk/xmtrade/isot/types/IDM/2016/04/01"
message-code="809" ...>
        <!-- description of order -->
      </ns:ISOTEDATA>
    </ns:UploadResponse>
  </s:Body>
</s:Envelope>

```

3.1.5 IdmOrderBook

Web service *IdmOrderBook* allows market participant to access immediate data from order book (available quantities and prices) on intraday market.

Service implements the following method:

- *Download* – method for data acquisition of order book on intraday market,
- *DownloadH2HMatrix* – method for downloading of available cross-border capacities in the form of Hub-to-Hub matrix.

SOAP Download

Download method of *IdmOrderBook* web service operates in synchronous mode, i.e. the request is handled by the response within the same call.

Note for AMQP interfaces:

System of the market participant, which is concurrently connected to AMQP interface for intraday notifications, must insure that the processing of queues during *Download* method call will be paused. In other case order book update may be incorrectly processed, as during *Download* method call multiple changes can occur in order book, which won't be included in the results.

*Request structure description***Table 21** Request structure description - Method Download

DownloadRequest	Description
CDSREQ-VDT	Structure of request for data acquisition of intraday order book is in accordance with specification , where message-code=810 (see description of E-08_01 data flow).

Table 22 Request structure description - Method DownloadH2HMatrix

DownloadH2HMatrixRequest	Opis
CDSREQ-VDT	Structure of request for data acquisition of intraday cross-border capacities within cross-border intraday marketis in accordance with specification , where message-code=840 (see description of E-08_02 data flow).

*Response structure description***Table 23** Response structure description - Method Download

DownloadResponse	Description
RESPONSE-VDT	Common structure of retrieving processing status is in accordance with specification , where message-code=811 (see description of E-08_01 data flow).
ISOTEDATA-VDT	Structure for accessing data from order book is in accordance with specification , where message-code=812 (see description of E-08_01 data flow).

SOAP message example

Request:

```

POST /Orders.WCF.Host/ServiceReference.svc HTTP/1.1
Content-Type:application/soap+xml; charset=utf-8
Host: ...
Content-Length: ...
Expect: 100-continue
Connection: Keep-Alive

<s:Envelope xmlns:s="http://www.w3.org/2003/05/soap-envelope"
xmlns:u="http://docs.oasis-open.org/wss/2004/01/oasis-200401-wss-wssecurity-
utility-1.0.xsd">
  <s:Header>
    <!-- WS-Addressing -->
    <!-- WS-Security -->
  </s:Header>
  <s:Body u:Id="_1">
    <ns:DownloadRequest
xmlns:ns="http://sfera.sk/ws/xmtrade/isot/interfaces/evaluations/services/2009/0
4/01">
      <ns:CDSREQ
xmlns="http://sfera.sk/ws/xmtrade/isot/interfaces/ut/types/2009/04/01"
id="1" message-code="810" date-time="2017-05-01T11:48:51" >
        <!-- message data for order book retrieval-->
      </ns:CDSREQ>
    </ns:DownloadRequest>
  </s:Body>
</s:Envelope>

```

Response:

```

HTTP/1.1 200 OK
Server: ASP.NET Development Server/9.0.0.0
Date: Sun, 30 Nov 2016 16:58:25 GMT
X-AspNet-Version: 2.0.50727
Cache-Control: private
Content-Type: application/soap+xml; charset=utf-8
Content-Length: ...
Connection: Close

<s:Envelope xmlns:s="http://www.w3.org/2003/05/soap-envelope"
xmlns:u="http://docs.oasis-open.org/wss/2004/01/oasis-200401-wss-wssecurity-
utility-1.0.xsd">
  <s:Header>
    <!-- WS-Addressing -->
    <!-- WS-Security -->
  </s:Header>
  <s:Body u:Id="_1">
    <ns:UploadResponse
xmlns:ns="http://sfera.sk/ws/xmtrade/isot/interfaces/idmorders/services/2016/04/0
1">
      <ns:RESPONSE xmlns="http://sfera.sk/ws/xmtrade/isot/ut/types/2009/04/01"
message-code="811" ...>
        <!-- status of request processing -->
      </ns:RESPONSE>
      <ns:ISOTEDATA xmlns="http://sfera.sk/xmtrade/isot/types/IDM/2016/04/01"
message-code="812" ...>
        <!-- data from order book -->
      </ns:ISOTEDATA>
    </ns:UploadResponse>
  </s:Body>
</s:Envelope>

```

3.1.6 IdaOrders

Web service *IdaOrders* provides market participants with automated interface for submission and reception of own orders on intraday auctions.

Web service allows following methods:

- *Upload* – method for submission orders for intraday auction,
- *Download* – method for retrieval of own orders submitted on intraday auction.

SOAP Upload

Method *Upload* of the web service *IdaOrders* works in synchronous regime, i.e. the request is handled by the response within the same call.

Description of request structure

Table 24 Request structure description –Upload method

UploadRequest	Opis
ISOTEDATA	Štruktúra objednávky/pokynu podľa špecifikácie , pričom message-code=851 (pozri Opis dátového toku E-09_01).

Description of response structure

Table 25 Response structure description – Upload method

UploadResponse	Opis
RESPONSE	Common return structure of request handling effectivity is in accordance with specification where message-code=812 (see description of data flow E-09_01).
ISOTEDATA	Structure of order is in accordance with specification where message-code=813 (see description data flow E-09_01). Description of order is returned as it was registered in the system.

Example of SOAP message

Request:

```

POST /Orders.WCF.Host/ServiceReference.svc HTTP/1.1
Content-Type: application/soap+xml; charset=utf-8
Host: ...
Content-Length: ...
Expect: 100-continue
Connection: Keep-Alive

<s:Envelope xmlns:s="http://www.w3.org/2003/05/soap-envelope"
xmlns:u="http://docs.oasis-open.org/wss/2004/01/oasis-200401-wss-wssecurity-utility-
1.0.xsd">
  <s:Header>
    <!-- WS-Addressing -->
    <!-- WS-Security -->
  </s:Header>
  <s:Body u:Id="_1">
    <ns:UploadRequest
xmlns:ns="http://sfera.sk/ws/xmtrade/isot/interfaces/orders/services/2009/04/01">
      <ns:ISOTEDATA
xmlns="http://sfera.sk/ws/xmtrade/isot/interfaces/orders/types/2009/04/01" id="1"
message-code="851" date-time="2009-05-01T11:48:51" answer-required="1">
        <!-- order data -->
        </ns:ISOTEDATA>
      </ns:UploadRequest>
    </s:Body>
  </s:Envelope>

```

Response:

```

HTTP/1.1 200 OK
Server: ASP.NET Development Server/9.0.0.0
Date: Sun, 30 Nov 2008 16:58:25 GMT
X-AspNet-Version: 2.0.50727
Cache-Control: private
Content-Type: application/soap+xml; charset=utf-8
Content-Length: ...
Connection: Close

<s:Envelope xmlns:s="http://www.w3.org/2003/05/soap-envelope"
xmlns:u="http://docs.oasis-open.org/wss/2004/01/oasis-200401-wss-wssecurity-utility-
1.0.xsd">
  <s:Header>
    <!-- WS-Addressing -->
    <!-- WS-Security -->
  </s:Header>
  <s:Body u:Id="_1">
    <ns:UploadResponse
xmlns:ns="http://sfera.sk/ws/xmtrade/isot/interfaces/orders/services/2009/04/01">
      <ns:RESPONSE xmlns="http://sfera.sk/ws/xmtrade/isot/ut/types/2009/04/01"
message-code="812" ...>
        <!-- efficiency description -->
        </ns:RESPONSE>
      <ns:ISOTEDATA
xmlns="http://sfera.sk/ws/xmtrade/isot/interfaces/orders/types/2009/04/01" message-
code="813" ...>
        <!-- order data description -->
        </ns:ISOTEDATA>
      </ns:UploadResponse>
    </s:Body>
  </s:Envelope>

```

SOAP Download

Download method of *Orders* service operates in synchronous mode, i.e. the request is handled by the response within the same call.

*Description of request structure***Table 26** Request structure description – Download method

DownloadRequest	Description
CDSREQ	Request structure for reception of own order in accordance with specification , where message-code=831 (see description of E-09_02 data flow).

*Description of response structure***Table 27** Response structure description – Download method

DownloadResponse	Description
RESPONSE	Common return structure of request handling effectivity in accordance with specification, where message-code=832 (see description of E-09_02 data flow).
ISOTEDATA	Structure of order in accordance with specification , where message-code=833 (see description of E-09_02 data flow). Description of order is returned as it was registered in the system.

SOAP message examples

Request:

```
POST /Orders.WCF.Host/ServiceReference.svc HTTP/1.1
Content-Type:application/soap+xml; charset=utf-8
Host: ...
Content-Length: ...
Expect: 100-continue
Connection: Keep-Alive

<s:Envelope xmlns:s="http://www.w3.org/2003/05/soap-envelope"
xmlns:u="http://docs.oasis-open.org/wss/2004/01/oasis-200401-wss-wssecurity-utility-
1.0.xsd">
  <s:Header>
    <!-- WS-Addressing -->
    <!-- WS-Security -->
  </s:Header>
  <s:Body u:Id="_1">
    <ns:DownloadRequest
xmlns:ns="http://sfera.sk/ws/xmtrade/isot/interfaces/orders/services/2009/04/01">
      <ns:CDSREQ
xmlns="http://sfera.sk/ws/xmtrade/isot/interfaces/ut/types/2009/04/01" id="1"
message-code="831" date-time="2009-05-01T11:48:51" >
        <Trade trade-day="2023-12-01" auction-id="IDA1" />
      </ns:CDSREQ>
    </ns:DownloadRequest>
  </s:Body>
</s:Envelope>
```

Response:

```

HTTP/1.1 200 OK
Server: ASP.NET Development Server/9.0.0.0
Date: Sun, 30 Nov 2008 16:58:25 GMT
X-AspNet-Version: 2.0.50727
Cache-Control: private
Content-Type: application/soap+xml; charset=utf-8
Content-Length: ...
Connection: Close

<s:Envelope xmlns:s="http://www.w3.org/2003/05/soap-envelope"
xmlns:u="http://docs.oasis-open.org/wss/2004/01/oasis-200401-wss-wssecurity-utility-
1.0.xsd">
  <s:Header>
    <!-- WS-Addressing -->
    <!-- WS-Security -->
  </s:Header>
  <s:Body u:Id="_1">
    <ns:DownloadResponse
xmlns:ns="http://sfera.sk/ws/xmtrade/isot/interfaces/orders/services/2009/04/01">
      <ns:RESPONSE xmlns="http://sfera.sk/ws/xmtrade/isot/ut/types/2009/04/01"
message-code="832" ... >
        <!-- efficiency description -->
      </ns:RESPONSE>
      <ns:ISOTEDATA
xmlns="http://sfera.sk/ws/xmtrade/isot/interfaces/orders/types/2009/04/01" message-
code="833" ... >
        <!-- order data description -->
      </ns:ISOTEDATA>
    </ns:DownloadResponse>
  </s:Body>
</s:Envelope>

```

3.1.7 Evaluations

Evaluations web service allows market participants to use automated interface for results/evaluations retrieval of day-ahead market.

The service implements the following methods:

- Download – method for retrieval of own results/evaluations of day-ahead market.

SOAP Download

Download method of *Evaluations* service operates in synchronous mode, i.e. the request is handled by the response within the same call.

Request structure description

Table 28 Request structure description – Download method

DownloadRequest	Description
CDSREQ	Request structure for retrieval of own order is in accordance with specification , where message-code=941, 951 or 961 (see description of E-03_02 , E-05_01 , E-05_02 data flows).

*Response structure description***Table 29** Response structure description – Download method

DownloadResponse	Description
RESPONSE	Common return structure of retrieving processing status is in accordance with specification, whereas message-code=942, 952 or 962 (see description of E-03_02 , E-05_01 , E-05_02 data flows).
ISOTEDATA	Structure of results/evaluations is in accordance with specification where message-code=943, 953 or 963 (see description of E-03_02 , E-05_01 , E-05_02 data flows).

*Example of SOAP message***Request:**

```

POST /Orders.WCF.Host/ServiceReference.svc HTTP/1.1
Content-Type:application/soap+xml; charset=utf-8
Host: ...
Content-Length: ...
Expect: 100-continue
Connection: Keep-Alive

<s:Envelope xmlns:s="http://www.w3.org/2003/05/soap-envelope"
xmlns:u="http://docs.oasis-open.org/wss/2004/01/oasis-200401-wss-wssecurity-
utility-1.0.xsd">
  <s:Header>
    <!-- WS-Addressing -->
    <!-- WS-Security -->
  </s:Header>
  <s:Body u:Id="_1">
    <ns:DownloadRequest
xmlns:ns="http://sfera.sk/ws/xmtrade/isot/interfaces/evaluations/services/2009/0
4/01">
      <ns:CDSREQ
xmlns="http://sfera.sk/ws/xmtrade/isot/interfaces/ut/types/2009/04/01" id="1"
message-code="941" date-time="2009-05-01T11:48:51" >
        <Trade trade-day="2009-05-01" />
      </ns:CDSREQ>
    </ns:DownloadRequest>
  </s:Body>
</s:Envelope>

```

Response:

```

HTTP/1.1 200 OK
Server: ASP.NET Development Server/9.0.0.0
Date: Sun, 30 Nov 2008 16:58:25 GMT
X-AspNet-Version: 2.0.50727
Cache-Control: private
Content-Type: application/soap+xml; charset=utf-8
Content-Length: ...
Connection: Close

<s:Envelope xmlns:s="http://www.w3.org/2003/05/soap-envelope"
xmlns:u="http://docs.oasis-open.org/wss/2004/01/oasis-200401-wss-wssecurity-
utility-1.0.xsd">
  <s:Header>
    <!-- WS-Addressing -->
    <!-- WS-Security -->
  </s:Header>
  <s:Body u:Id="_1">
    <ns:DownloadResponse
xmlns:ns="http://sfera.sk/ws/xmtrade/isot/interfaces/orders/services/2009/04/01">
      <ns:RESPONSE xmlns="http://sfera.sk/ws/xmtrade/isot/ut/types/2009/04/01"
message-code="942" ... >
        <!-- description of processing status -->
      </ns:RESPONSE>
      <ns:ISOTEDATA
xmlns="http://sfera.sk/ws/xmtrade/isot/interfaces/orders/types/2009/04/01"
message-code="943" ... >
        <!-- description of DM results -->
      </ns:ISOTEDATA>
    </ns:DownloadResponse>
  </s:Body>
</s:Envelope>

```

3.1.8 IdmEvaluations

IdmEvaluations web service allows market participants to use automated interface for results/evaluations retrieval of intraday market.

The service implements the following methods:

- Download – method for retrieval of own results/evaluations on intraday market.

SOAP Download

Download method of *IdmEvaluations* service operates in synchronous mode, i.e. the request is handled by the response within the same call.

Request structure description

Table 30 Request structure description – Download method

DownloadRequest	Description
CDSREQ-VDT	Request structure description for IDM results for market participant is in accordance with specification , where message-code=961 (see data flow description E-07_01) for daily results, message-code=571 (see data flow description E-07_02) for monthly results message-code=951 (see data flow description E-07_03) for results per periods.

Response structure description

Table 31 Response structure description – Download method

DownloadResponse	Description
RESPONSE-VDT	Common return structure of retrieving processing status is in accordance with specification, whereas message-code=962,572 or 952 (see description of E-07_01, E-07_02, E-07_03 data flows).
ISOTEDATA-VDT	Structure of results/evaluations is in accordance with specification where message-code=963,573 or 953 (see description of E-07_021, E-07_02, E-07_03 data flows).

SOAP message example

Request:

```

POST /IdmOrders.WCF.Host/ServiceReference.svc HTTP/1.1
Content-Type:application/soap+xml; charset=utf-8
Host: ...
Content-Length: ...
Expect: 100-continue
Connection: Keep-Alive

<s:Envelope xmlns:s="http://www.w3.org/2003/05/soap-envelope"
xmlns:u="http://docs.oasis-open.org/wss/2004/01/oasis-200401-wss-wssecurity-
utility-1.0.xsd">
  <s:Header>
    <!-- WS-Addressing -->
    <!-- WS-Security -->
  </s:Header>
  <s:Body u:Id="_1">
    <ns:DownloadRequest
xmlns:ns="http://sfera.sk/ws/xmtrade/isot/interfaces/idmevaluations/services/201
6/04/01">
      <ns:CDSREQ
xmlns="http://sfera.sk/ws/xmtrade/isot/interfaces/ut/types/2009/04/01" id="1"
message-code="961" date-time="2016-05-01T11:48:51" >
        <Trade trade-day="2016-05-01" />
      </ns:CDSREQ>
    </ns:DownloadRequest>
  </s:Body>
</s:Envelope>

```

Response:

```

HTTP/1.1 200 OK
Server: ASP.NET Development Server/9.0.0.0
Date: Sun, 30 Nov 2016 16:58:25 GMT
X-AspNet-Version: 2.0.50727
Cache-Control: private
Content-Type: application/soap+xml; charset=utf-8
Content-Length: ...
Connection: Close

<s:Envelope xmlns:s="http://www.w3.org/2003/05/soap-envelope"
xmlns:u="http://docs.oasis-open.org/wss/2004/01/oasis-200401-wss-wssecurity-
utility-1.0.xsd">
  <s:Header>
    <!-- WS-Addressing -->
    <!-- WS-Security -->
  </s:Header>
  <s:Body u:Id="_1">
    <ns:DownloadResponse
xmlns:ns="http://sfera.sk/ws/xmtrade/isot/interfaces/idmevaluations/services/2016
/04/01">
      <ns:RESPONSE xmlns="http://sfera.sk/ws/xmtrade/isot/ut/types/2009/04/01"
message-code="962" ... >
        <!--processing status -->
      </ns:RESPONSE>
      <ns:ISOTEDATA
xmlns="http://sfera.sk/ws/xmtrade/isot/interfaces/idmevaluations/types/2009/04/01
" message-code="963" ... >
        <!--IDM results description -->
      </ns:ISOTEDATA>
    </ns:DownloadResponse>
  </s:Body>
</s:Envelope>

```

3.1.9 IdaEvaluations

IdaEvaluations web service allows market participants to use automated interface for results/evaluations retrieval of intraday auctions.

The service implements the following methods:

- Download – method for retrieval of own results/evaluations of intraday auctions.

SOAP Download

Download method of *IdaEvaluations* service operates in synchronous mode, i.e. the request is handled by the response within the same call.

Request structure description

Table 32 Request structure – Download method

DownloadRequest	Opis
CDSREQ	Request structure for retrieval of own order is in accordance with specification , where message-code=941, 951 or 961 (see description of E-11_01, E-11_02, E-11_03 data flows).

Opis štruktúry odpovede

Table 33 Response structure - Download method

DownloadResponse	Opis
RESPONSE	Common return structure of retrieving processing status is in accordance with specification, whereas message-code=942, 952 or 962 (see description of E-11_01, E-11_02, E-11_03 data flows).
ISOTEDATA	Structure of results/evaluations is in accordance with specification where message-code=943, 953 or 963 (see description of E-11_01, E-11_02, E-11_03 data flows).

SOAP message examples

Request:

```
POST /Orders.WCF.Host/ServiceReference.svc HTTP/1.1
Content-Type: application/soap+xml; charset=utf-8
Host: ...
Content-Length: ...
Expect: 100-continue
Connection: Keep-Alive

<s:Envelope xmlns:s="http://www.w3.org/2003/05/soap-envelope"
xmlns:u="http://docs.oasis-open.org/wss/2004/01/oasis-200401-wss-wssecurity-utility-
1.0.xsd">
  <s:Header>
    <!-- WS-Addressing -->
    <!-- WS-Security -->
  </s:Header>
  <s:Body u:Id="_1">
    <ns:DownloadRequest
xmlns:ns="http://sfera.sk/ws/xmtrade/isot/interfaces/evaluations/services/2009/04/01"
>
      <ns:CDSREQ
xmlns="http://sfera.sk/ws/xmtrade/isot/interfaces/ut/types/2009/04/01" id="1"
message-code="941" date-time="2023-12-01T11:48:51" >
        <Trade trade-day="2023-12-01" auction-id="IDA1"/>
      </ns:CDSREQ>
    </ns:DownloadRequest>
  </s:Body>
</s:Envelope>
```

Response:

```

HTTP/1.1 200 OK
Server: ASP.NET Development Server/9.0.0.0
Date: Sun, 30 Nov 2008 16:58:25 GMT
X-AspNet-Version: 2.0.50727
Cache-Control: private
Content-Type: application/soap+xml; charset=utf-8
Content-Length: ...
Connection: Close

<s:Envelope xmlns:s="http://www.w3.org/2003/05/soap-envelope"
xmlns:u="http://docs.oasis-open.org/wss/2004/01/oasis-200401-wss-wssecurity-utility-
1.0.xsd">
  <s:Header>
    <!-- WS-Addressing -->
    <!-- WS-Security -->
  </s:Header>
  <s:Body u:Id="_1">
    <ns:DownloadResponse
xmlns:ns="http://sfera.sk/ws/xmtrade/isot/interfaces/orders/services/2009/04/01">
      <ns:RESPONSE xmlns="http://sfera.sk/ws/xmtrade/isot/ut/types/2009/04/01"
message-code="942" ... >
        <!-- efficiency description -->
      </ns:RESPONSE>
      <ns:ISOTEDATA
xmlns="http://sfera.sk/ws/xmtrade/isot/interfaces/orders/types/2009/04/01" message-
code="943" ... >
        <!-- IDA results description -->
      </ns:ISOTEDATA>
    </ns:DownloadResponse>
  </s:Body>
</s:Envelope>

```

3.1.10 StatusRequest

StatusRequest web service allows market participants to use automated interface for status/information retrieval about processes within *ENTSO-E* specification. Currently it provides an option to retrieve MCC values.

The service implements the following methods:

- DownloadMCC – method for MCC values retrieval for a given trading day.

SOAP DownloadMCC

DownloadMCC method of *StatusRequest* service operates in synchronous mode, i.e. the request is handled by the response within the same call.

Request structure description

Table 34 Request structure description – DownloadMCC method

DownloadMCCRequest	Description
StatusRequest	Request structure for retrieval of MCC values is in accordance with ESR.StatusRequest specification.

*Response structure description***Table 35** Response structure description – DownloadMCC method

DownloadMCCResponse	Description
Acknowledgement	Common return structure of for retrieving processing status is in accordance with EAD.Acknowledgement specification.
CapacityDocument	Structure is in accordance with ECAN.CapacityDocument specification.

Example of SOAP message

Request:

```

POST /StatusRequest.WCF.Host/ServiceReference.svc HTTP/1.1
Content-Type:application/soap+xml; charset=utf-8
Host: ...
Content-Length: ...
Expect: 100-continue
Connection: Keep-Alive

<s:Envelope xmlns:s="http://www.w3.org/2003/05/soap-envelope"
xmlns:u="http://docs.oasis-open.org/wss/2004/01/oasis-200401-wss-wssecurity-
utility-1.0.xsd">
  <s:Header>
    <!-- WS-Addressing -->
    <!-- WS-Security -->
  </s:Header>
  <s:Body u:Id="_1">
    <ns:DownloadMCCRequest
xmlns:ns="http://sfera.sk/ws/xmtrade/isot/interfaces/statusrequest/services/2009/
04/01">
      <ns:StatusRequest DtdVersion="1" DtdRelease="1"
xmlns="http://sfera.sk/ws/xmtrade/isot/common/types/esrv1r1/2009/04/01">
        <!-- Request description -->
      </ns:StatusRequest>
    </ns:DownloadMCCRequest>
  </s:Body>
</s:Envelope>

```

Response:

```

HTTP/1.1 200 OK
Server: ASP.NET Development Server/9.0.0.0
Date: Sun, 30 Nov 2008 16:58:25 GMT
X-AspNet-Version: 2.0.50727
Cache-Control: private
Content-Type: application/soap+xml; charset=utf-8
Content-Length: ...
Connection: Close

<s:Envelope xmlns:s="http://www.w3.org/2003/05/soap-envelope"
xmlns:u="http://docs.oasis-open.org/wss/2004/01/oasis-200401-wss-wssecurity-
utility-1.0.xsd">
  <s:Header>
    <!-- WS-Addressing -->
    <!-- WS-Security -->
  </s:Header>
  <s:Body u:Id="_1">
    <ns:DownloadMCCResponse
xmlns:ns="http://sfera.sk/ws/xmtrade/isot/interfaces/statusrequest/services/2009/
04/01">
      <ns:Acknowledgement
xmlns="http://sfera.sk/ws/xmtrade/isot/common/types/ackv5r0/2009/04/01">
        <!-- request processing status -->
      </ns:Acknowledgement >
      <ns:CapacityDocument
xmlns="http://sfera.sk/ws/xmtrade/isot/common/types/ecan/2009/04/01">
        <!-- MCC Description -->
      </ns:CapacityDocument >
    </ns:DownloadResponse>
  </s:Body>
</s:Envelope>

```

3.1.11 Communication Security

Web services are available exclusively through secured *https* protocol that allows encryption of transmitted messages. Therefore, messages at the SOAP protocol level are not encrypted.

Web service interfaces are secured in accordance with *WS-Security (WSS)* standard, version 1.0, pursuant to which the following techniques of security are designed:

- Electronic signature of sent SOAP requests and responses,
- Transmission of authentication details within SOAP request (username/password, certificate).

Electronic signature

Support for electronic signature of SOAP messages is secured within implementation of *WS-Security* standard, version 1.0.

(http://www.oasis-open.org/committees/tc_home.php?wg_abbrev=wss).

Signature is stored in the header of SOAP message, i.e. separately from the message body transmitting data. *WSS* standard implements the signature on *xmldsig* standard (<http://www.w3.org/TR/xmldsig-core>).

Following signed elements are required:

- message body (s:Body),
- username/password token of a user (o:UsernameToken),
- timestamp (u:Timestamp),
- specification of method name of web service (a:Action),
- sender specification (a:ReplyTo),
- message identification (a:MessageID),

- specification of service target address (a:To).

Example of SOAP message

The following example demonstrates the message structure consisting of soap message elements (envelope), header (header), address specification header elements and security and message body.

Beginning

```
<s:Envelope
  xmlns:s="http://www.w3.org/2003/05/soap-envelope"
  xmlns:a="http://schemas.xmlsoap.org/ws/2004/08/addressing"
  xmlns:u="http://docs.oasis-open.org/wss/2004/01/oasis-200401-wss-wssecurity-utility-1.0.xsd">
  <s:Header>
```

WS-Addressing

```
<a:Action s:mustUnderstand="1" u:Id="id-17567474" xmlns:u="http://docs.oasis-open.org/wss/2004/01/oasis-200401-wss-wssecurity-utility-1.0.xsd">http://sfera.sk/ws/xmtrade/isot/interfaces/NameOfService/services/2009/04/01/NameOfServiceContract/NameOfMethod</a:Action>
<a:ReplyTo s:mustUnderstand="1" u:Id="id-235207" xmlns:u="http://docs.oasis-open.org/wss/2004/01/oasis-200401-wss-wssecurity-utility-1.0.xsd">
  <a:Address>http://schemas.xmlsoap.org/ws/2004/08/addressing/role/anonymous</a:Address>
</a:ReplyTo>
<a:MessageID s:mustUnderstand="1" u:Id="id-11090325" xmlns:u="http://docs.oasis-open.org/wss/2004/01/oasis-200401-wss-wssecurity-utility-1.0.xsd">b83ac27b-9a4f-40e3-a782-96df2cbea73e</a:MessageID>
<a:To s:mustUnderstand="1" u:Id="id-27256294" xmlns:u="http://docs.oasis-open.org/wss/2004/01/oasis-200401-wss-wssecurity-utility-1.0.xsd">ServiceAddress</a:To>
```

WS-Security

```

<o:Security xmlns:o="http://docs.oasis-open.org/wss/2004/01/oasis-200401-wss-wssecurity-secext-1.0.xsd">
  <o:BinarySecurityToken EncodingType="http://docs.oasis-open.org/wss/2004/01/oasis-200401-wss-message-security-1.0#Base64Binary" ValueType="http://docs.oasis-open.org/wss/2004/01/oasis-200401-wss-x509-token-profile-1.0#X509v3" u:Id="CertId-17206535" xmlns:u="http://docs.oasis-open.org/wss/2004/01/oasis-200401-wss-wssecurity-utility-1.0.xsd"><!-- REMOVED -->
</o:BinarySecurityToken>
  <d:Signature Id="Signature-190585" xmlns:d="http://www.w3.org/2000/09/xmldig#">
    <d:SignedInfo>
      <d:CanonicalizationMethod Algorithm="http://www.w3.org/2001/10/xml-exc-c14n#" />
      <d:SignatureMethod Algorithm="http://www.w3.org/2000/09/xmldig#rsa-sha1" />
      <d:Reference URI="#UsernameToken-13236543">
        <d:Transforms><d:Transform Algorithm="http://www.w3.org/2001/10/xml-exc-c14n#" />
          </d:Transforms>
        <d:DigestMethod Algorithm="http://www.w3.org/2000/09/xmldig#sha1" />
        <d:DigestValue>lm0E+rpDJ8oSP8Fh+ZlqZRiMjc8</d:DigestValue>
      </d:Reference>
      <d:Reference URI="#Timestamp-2175170">
        <d:Transforms><d:Transform Algorithm="http://www.w3.org/2001/10/xml-exc-c14n#" />
          </d:Transforms>
        <d:DigestMethod Algorithm="http://www.w3.org/2000/09/xmldig#sha1" />
        <d:DigestValue>02CsUF1As77a6I3+BkQZ22TogWI=</d:DigestValue>
      </d:Reference>
      <d:Reference URI="#id-4652787">
        <d:Transforms><d:Transform Algorithm="http://www.w3.org/2001/10/xml-exc-c14n#" />
          </d:Transforms>
        <d:DigestMethod Algorithm="http://www.w3.org/2000/09/xmldig#sha1" />
        <d:DigestValue>ktXRJoijcGSFrHaUKaLXUnH43XU=</d:DigestValue>
      </d:Reference>
      <d:Reference URI="#id-17567474">
        <d:Transforms><d:Transform Algorithm="http://www.w3.org/2001/10/xml-exc-c14n#" />
          </d:Transforms>
        <d:DigestMethod Algorithm="http://www.w3.org/2000/09/xmldig#sha1" />
        <d:DigestValue>lLOeuXRDl1Gs5IX+zvaWuFIhVzw=</d:DigestValue>
      </d:Reference>
      <d:Reference URI="#id-11090325">
        <d:Transforms><d:Transform Algorithm="http://www.w3.org/2001/10/xml-exc-c14n#" />
          </d:Transforms>
        <d:DigestMethod Algorithm="http://www.w3.org/2000/09/xmldig#sha1" />
        <d:DigestValue>ZsiiDzGRLHuyb8bKASKDo8ryoqc=</d:DigestValue>
      </d:Reference>
      <d:Reference URI="#id-235207">
        <d:Transforms><d:Transform Algorithm="http://www.w3.org/2001/10/xml-exc-c14n#" />
          </d:Transforms>
        <d:DigestMethod Algorithm="http://www.w3.org/2000/09/xmldig#sha1" />
        <d:DigestValue>9p44ZJinb/97IP1X0C7yFayRHpc=</d:DigestValue>
      </d:Reference>
      <d:Reference URI="#id-27256294">
        <d:Transforms><d:Transform Algorithm="http://www.w3.org/2001/10/xml-exc-c14n#" />
          </d:Transforms>
        <d:DigestMethod Algorithm="http://www.w3.org/2000/09/xmldig#sha1" />
        <d:DigestValue>BCxp9HRQ6cJAykEdliom9mU86vA=</d:DigestValue>
      </d:Reference>
    </d:SignedInfo>
    <d:SignatureValue><!-- REMOVED --></d:SignatureValue>
    <d:KeyInfo Id="KeyId-33119438">
      <o:SecurityTokenReference u:Id="STRId-28732159" xmlns:u="http://docs.oasis-open.org/wss/2004/01/oasis-200401-wss-wssecurity-utility-1.0.xsd">
        <o:Reference URI="#CertId-17206535" ValueType="http://docs.oasis-open.org/wss/2004/01/oasis-200401-wss-x509-token-profile-1.0#X509v3" />
      </o:SecurityTokenReference>
    </d:KeyInfo>
  </d:Signature>
  <o:UsernameToken u:Id="UsernameToken-13236543" xmlns:u="http://docs.oasis-open.org/wss/2004/01/oasis-200401-wss-wssecurity-utility-1.0.xsd">
    <o:Username><!-- REMOVED --></o:Username>
    <o:Password Type="http://docs.oasis-open.org/wss/2004/01/oasis-200401-wss-username-token-profile-1.0#PasswordText"><!-- REMOVED --></o:Password>
  </o:UsernameToken>
  <u:Timestamp u:Id="Timestamp-2175170" xmlns:u="http://docs.oasis-open.org/wss/2004/01/oasis-200401-wss-wssecurity-utility-1.0.xsd">
    <u:Created>2009-07-01T09:24:06.011Z</u:Created>
    <u:Expires>2009-07-01T12:10:46.011Z</u:Expires>
  </u:Timestamp>
</o:Security>

```

Header ending + body + message ending

```
</s:Header>
  <s:Body u:Id="id-4652787">
    <!-- request body -->
  </s:Body>
</s:Envelope>
```

Authentication and authorization of web service call

Web services are secured against unauthorized use. System user is required to have an assigned user account in XMtrade®/ISOT system with the client certificate for signing and verification of identity. User is required to have assigned rights for calling relevant web services.

3.1.12 Description of web services

Description of web services of the market organizer information system XMtrade®/ISOT is given in the form of WSDL (<http://www.w3.org/TR/wsdl>) documents on the following addresses.

Production environment

Table 36 Description of web services XMtrade®/ISOT – production environment

ID	Web service name	Service address /WSDL document
OB-01	Orders	https://isot.okte.sk/interfaces/Orders/Service.svc https://isot.okte.sk/interfaces/Orders/Service.svc?wsdl
OB-02	IdmOrders	https://isot.okte.sk/interfaces/IdmOrders/Service.svc https://isot.okte.sk/interfaces/IdmOrders/Service.svc?wsdl
OB-03	IdmOrderBook	https://isot.okte.sk/interfaces/IdmOrderBook/Service.svc https://isot.okte.sk/interfaces/IdmOrderBook/Service.svc?wsdl
OB-04	IdaOrders	https://isot.okte.sk/interfaces/IdaOrders/Service.svc https://isot.okte.sk/interfaces/IdaOrders/Service.svc?wsdl
EV-01	Evaluations	https://isot.okte.sk/interfaces/Evaluations/Service.svc https://isot.okte.sk/interfaces/Evaluations/Service.svc?wsdl
EV-02	IdmEvaluations	https://isot.okte.sk/interfaces/IdmEvaluations/Service.svc https://isot.okte.sk/interfaces/IdmEvaluations/Service.svc?wsdl
EV-03	IdaEvaluations	https://isot.okte.sk/interfaces/IdaEvaluations/Service.svc https://isot.okte.sk/interfaces/IdaEvaluations/Service.svc?wsdl
SR-01	StatusRequest	https://isot.okte.sk/interfaces/StatusRequest/Service.svc https://isot.okte.sk/interfaces/StatusRequest/Service.svc?wsdl

SANDBOX environment

Table 37 Description of web services XMtrade®/ISOT – SANDBOX environment

ID	Web service name	Service address /WSDL document
<u>OB-01</u>	<u>Orders</u>	https://sandbox-isot.okte.sk/interfaces/Orders/Service.svc https://sandbox-isot.okte.sk/interfaces/Orders/Service.svc?wsdl
<u>OB-02</u>	<u>IdmOrders</u>	https://sandbox-isot.okte.sk/interfaces/IdmOrders/Service.svc

<u>ID</u>	<u>Web service name</u>	<u>Service address /WSDL document</u>
		https://sandbox-isot.okte.sk/interfaces/IdmOrders/Service.svc?wsdl
<u>OB-03</u>	<u>IdmOrderBook</u>	https://sandbox-isot.okte.sk/interfaces/IdmOrderBook/Service.svc https://sandbox-isot.okte.sk/interfaces/IdmOrderBook/Service.svc?wsdl
<u>OB-04</u>	<u>IdaOrders</u>	https://sandbox-isot.okte.sk/interfaces/IdaOrders/Service.svc https://sandbox-isot.okte.sk/interfaces/IdaOrders/Service.svc?wsdl
<u>EV-01</u>	<u>Evaluations</u>	https://sandbox-isot.okte.sk/interfaces/Evaluations/Service.svc https://sandbox-isot.okte.sk/interfaces/Evaluations/Service.svc?wsdl
<u>EV-02</u>	<u>IdmEvaluations</u>	https://sandbox-isot.okte.sk/interfaces/IdmEvaluations/Service.svc https://sandbox-isot.okte.sk/interfaces/IdmEvaluations/Service.svc?wsdl
<u>EV-03</u>	<u>IdaEvaluations</u>	https://sandbox-isot.okte.sk/interfaces/IdaEvaluations/Service.svc https://sandbox-isot.okte.sk/interfaces/IdaEvaluations/Service.svc?wsdl
<u>SR-01</u>	<u>StatusRequest</u>	https://sandbox-isot.okte.sk/interfaces/StatusRequest/Service.svc https://sandbox-isot.okte.sk/interfaces/StatusRequest/Service.svc?wsdl

Testing environment

Table 37 **Table 38** Description of web services XMtrade®/ISOT – testing environment

ID	Web service name	Service address /WSDL document
OB-01	Orders	https://test-isot.okte.sk/interfaces/Orders/Service.svc https://test-isot.okte.sk/interfaces/Orders/Service.svc?wsdl
OB-02	IdmOrders	https://test-isot.okte.sk/interfaces/IdmOrders/Service.svc https://test-isot.okte.sk/interfaces/IdmOrders/Service.svc?wsdl
OB-03	IdmOrderBook	https://test-isot.okte.sk/interfaces/IdmOrderBook/Service.svc https://test-isot.okte.sk/interfaces/IdmOrderBook/Service.svc?wsdl
OB-04	IdaOrders	https://test-isot.okte.sk/interfaces/IdaOrders/Service.svc https://test-isot.okte.sk/interfaces/IdaOrders/Service.svc?wsdl
EV-01	Evaluations	https://test-isot.okte.sk/interfaces/Evaluations/Service.svc https://test-isot.okte.sk/interfaces/Evaluations/Service.svc?wsdl
EV-02	IdmEvaluations	https://test-isot.okte.sk/interfaces/IdmEvaluations/Service.svc https://test-isot.okte.sk/interfaces/IdmEvaluations/Service.svc?wsdl
EV-03	IdaEvaluations	https://test-isot.okte.sk/interfaces/IdaEvaluations/Service.svc https://test-isot.okte.sk/interfaces/IdaEvaluations/Service.svc?wsdl
SR-01	StatusRequest	https://test-isot.okte.sk/interfaces/StatusRequest/Service.svc https://test-isot.okte.sk/interfaces/StatusRequest/Service.svc?wsdl

ID	Web service name	Service address /WSDL document
		isot.okte.sk/interfaces/StatusRequest/Service.svc?wsdl

Addresses of testing environment services are almost identical to production addresses. They only differ in the domain name of the address: <https://sandbox-isot.okte.sk>, <https://test-isot.okte.sk> respectively instead of <https://isot.okte.sk>.

3.2 AMQP interface

AMQP interface is communication extension within intraday market. This interface improves possibilities of web services and allows full trading automation on intraday market through external interfaces.

AMQP interface allows market participants to receive notifications about their own orders and public changes in order book:

- Successful order submission and own order modification (change of status),
- Status change of order book (increase/decrease of available quantity).

AMQP interface is built on open source product [RabbitMQ](#) that implements AMQP protocol.

3.2.1 AMQP Protocol

AMQP (Advanced Message Queuing Protocol) is network protocol for high performance and reliable communication based on message exchange. AMQP is open standard for so called middleware messaging layers.

Versions of AMQP components:

- AMQP protocol: 0-9-1,
- RabbitMQ server: 3.6.x.

AMQP 0-9-1 uses concept of intermediary communication through so called brokers. Brokers receive messages from sender (message producer) and sends/routes the messages to consumer.

Technically, there are following elements in the protocol:

- Exchanges: input point/container to which sender sends messages.
- Queues: queue/destination address, on which broker delivers message based on basic rules (bindings).
- Bindings: rules for message delivering.

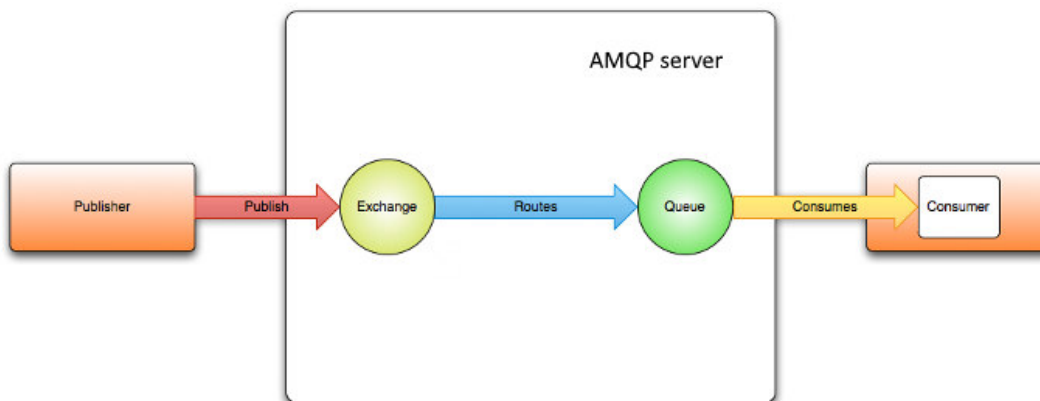

Figure 9 AMQP communication concept

Communication works on channel principle within one connection (TCP connection).

Basic description of AMQP communication principles and its elements can be found here: <https://www.rabbitmq.com/tutorials/amqp-concepts.html>.

3.2.2 Connecting to RabbitMQ server

RabbitMQ on <http://www.rabbitmq.com/clients.html> provides complex documentation for technical realization of connection and communication with it on various development platforms (Java, .NET). For these platforms, it provides complete libraries for clients.

Prerequisites for successful connection:

- only one connection per user account intended for AMQP communication,
- name of user account does not contain white symbols (space) or '.' (dot) sign,
- login certificate must be assigned to user account. This certificate must be issued with client authentication function and from supported certification authority.

For reliable long-term connection with AMQP server, it is recommended to create AMQP connection with heartbeat setting to minimum 5-20 seconds. Technical details can be found here: <https://www.rabbitmq.com/heartbeats.html>.

3.2.3 Communication scenarios

XMtrade®/ISOT system has several supported communication scenarios:

- **Broadcast** communication where system XMtrade®/ISOT sends notifications that are public and available to all market participants or private which are addressed only to particular market-participant. This type of connection is initiated by XMtrade®/ISOT system, and participants can then register for message subscription, which are interesting for them.

Broadcast

System XMtrade®/ISOT sends following types of information in the form of broadcast messages:

- Notifications about changes on intraday market.

Broadcast messages are distributed from system XMtrade®/ISOT through AMQP server to all connected users that are subscribed for given message type.

Notifications about changes on intraday market

Within intraday market, system provides notifications about changes related to own orders or public changes in order book, which occurred as a result of changes invoked by market participant (order submission etc.) or indirectly as a result of trade creation etc.

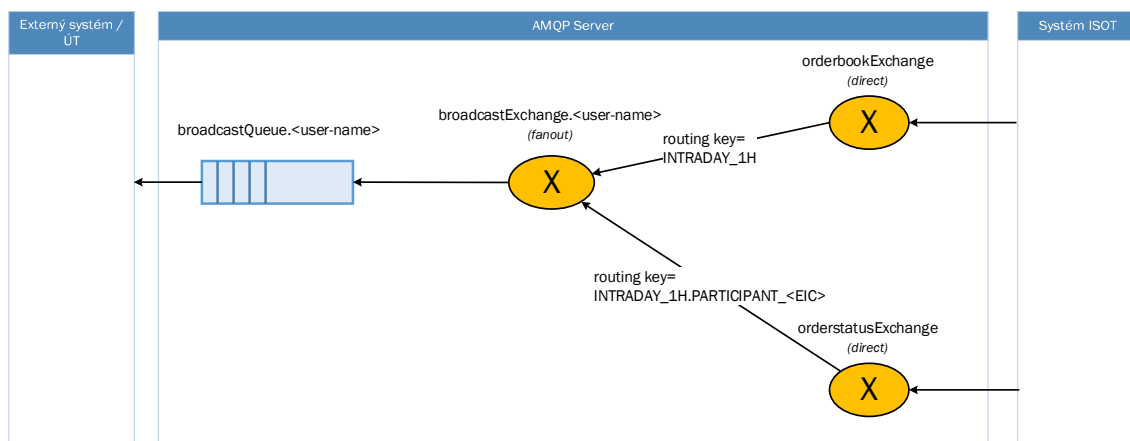

Figure 10 Scheme of notification messages flow on intraday market

Table 38 **Table 39** Data flow distribution keys tags description

Distribution keys	Description
INTRADAY_1H	Information of public nature related to 60-min products: - change in order book data (E-10_02).
INTRADAY_15M	Information of public nature related to 60-min products: - change in order book data (E-10_02)
INTRADAY_1H.PARTICIPANT_<EIC>	Information relevant for particular market participant, where <EIC> is EIC code of a market participant: - Change of status/creation of own order (E-10_01).
INTRADAY_H2H	Information of public nature: - Change of cross-border capacities in form of Hub-to-Hub (H2H) matrix (E-10_03)

Receiving notifications

For notification reception client (consumer) has to connect (subscribe) to private queue called *broadcastQueue.<user-name>*, where <user-name> is user name given after account registration. Queue on AMQP server is automatically created after account registration and access approval. Internally connection (binding) to system exchange objects with distribution keys corresponding to internal model for supported message routing is created.

User can register (subscribe) to message reception only from his private queue. Attempt to connect to a queue of a different user will fail.

All types of notifications that the user has authorization to will be distributed into private queue.

Broadcast queues are set up as permanent which means messages distributed into this queue will not be lost with client disconnect or short outage of XMtrade®/ISOT system. However, these broadcast messages have limited life span (for example 60 seconds) on grounds of AMQP server security. This precaution protects AMQP server from system resource depletion.

Failure cases

In case of AMQP server shutdown, all connections to broadcast queue are lost. However, if client is subscribed for so-called shutdown notification, AMQP server can respond to this situation. After the AMQP server is up, client has to create new connection and register private queues again.

In case of XMtrade®/ISOT system outage or malfunction, connection or registration to private queues is not lost but no new notifications will be added until XMtrade®/ISOT system is up and running.

In case of client outage (client is not connected to private queue) messages sent to this queue will be lost if the client will not connect for message consuming before maximum life span of broadcast messages is reached.

3.2.4 Communication security

Communication is cyphered on network layer with TLS protocol and authentication with client certificate while only TLS 1.2 and higher is accepted.

On <https://www.rabbitmq.com/ssl.html> web page, it is possible to find instructions for connecting with the required security prerequisites for example, Configuring TLS Version in Java Client chapters or more precisely Configuring the .NET Client and Presenting and validating certificates.

Authentication

For authentication, it is necessary to create connection on AMQP server with the following login credentials:

- Name/password.
- Client certificate for authentication on TLS protocol layer where mutual validation of client and server certificates occurs at which moment key and cryptographic algorithm for further communication is arranged.

AMQP server identifies user based on user name while verifies credentials mentioned above (checks password and certificate validity of the given user).

Authorization

Authorization works on two levels:

- AMQP server, which verifies users access to AMQP entities (queue, exchange, binding).
- System XMtrade®/ISOT, which sends messages only to authorized users (market participants).

3.2.5 Message format

All transferred AMQP messages contain UTF-8 coded data (payload) encapsulated in XML format and metadata on AMQP layer properties.

AMQP message properties

Every message has the following properties filled in metadata.

~~Table 39~~ **Table 40** Message properties in metadata description

AMQP Message Property	Description
content-type	Indicates the type of XML data and its version encapsulated in AMQP. These are the valid values: - x-isot-vdt/order-status, - x-isot-vdt/orderbook-status.
correlation-id	Serves for correlation on AMQP message layer. Allows correlation of requests filled through web services with broadcast messages for example activation of order with notification about order activation. In this case, the <i>correlation-id</i> is same as id attribute of the request sent in ISOTEDATA-VDT structure (see chapter 4.3.3). Correlation is also possible on XML data level through id attribute of reference structure element RESPONSE-VDT and ISOTEDATA-VDT.

3.2.6 AMQP server

Connection to AMQP server is established through AMQP specific URI with accordance to specification <https://www.rabbitmq.com/uri-spec.html>.

Production environment

URI parameters:

hostname	isot.okte.sk
port	5671 (TLS)
vhost	(empty)

Example URI on AMQP server:

amqp://userName:password@isot.okte.sk:5671/

TLS parameters:

Server certificate: *.okte.sk

SANDBOX environment**URI parameters:**

<u>hostname</u>	<u>sandbox-isot.okte.sk</u>
<u>port</u>	<u>5671 (TLS)</u>
<u>vhost</u>	<u>(empty)</u>

Example URI on AMQP server:

amqp://userName:password@sandbox-isot.okte.sk:5671/

TLS parameters:

Server certificate: *.okte.sk

Test environment**URI parameters:**

hostname	test-isot.okte.sk
port	5671 (TLS)
vhost	(empty)

Example URI on AMQP server:

amqp://userName:password@test-isot.okte.sk:5671/

TLS parameters:

Server certificate: *.okte.sk

4 SPECIFICATION OF DATA STRUCTURES

The market organizer information system XMtrade®/ISOT allows automated data exchange through interface that involves use of data structures based on XML format in accordance with *ENTSO-E* standards and data structures based on established XML formats of the IS OTE and IS OKTE systems:

- ENTSO-E Capacity Allocation and Nomination (ECAN)
(System of capacity allocation and nomination),
- ENTSO-E Acknowledgement Process (EAD)
(Process for acknowledgement documents),
- ENTSO-E Status Request (ESR)
(Retrieval of status information),
- Energy Identification Coding Scheme (EIC)
(System of identification in the energy sector),
- ENTSO-E General Code List for Data Interchange (ECL)
(Code lists used in *ENTSO-E* standards),
- ENTSO-E Harmonized Electricity Market Role Model
(Role model on the electricity market),
- ISOT: ISOTEDATA, ISOTEDATA-VDT, RESPONSE, RESPONSE-VDT, CDSREQ, CDSREQ-VDT.

(Structures are derived from the information system of market operator in the Czech Republic).

Date and time items in structures are used in UTC (Universal Time) format.

~~Table 40~~ **Table 41** Structures and data flows overview

Interface	Process	ID	Direction	Format
Market participant order administration	Reception of orders	E-02_01	Input	ISOTEDATA.811
			Output	RESPONSE.812 ISOTEDATA.813
	Provision of orders	E-02_03	Input	CDSREQ.831
			Output	RESPONSE.832 ISOTEDATA.833
ID market Order administration	Reception of orders	E-06_01	Input	ISOTEDATA-VDT.801
			Output	RESPONSE-VDT.802 ISOTEDATA-VDT.803
	Modification of orders	E-06_02	Input	ISOTEDATA-VDT.804
			Output	RESPONSE-VDT.805 ISOTEDATA-VDT.806
	Provision of orders	E-06_03	Input	CDSREQ-VDT.807
			Output	RESPONSE-VDT.808 ISOTEDATA-VDT.809

Interface	Process	ID	Direction	Format
ID market order book data	Access to order book	E-08_01	Input	CDSREQ-VDT.810
			Output	RESPONSE-VDT.811 ISOTEDATA-VDT.812
Results and evaluations of DM	Notification of results and evaluations	E-03_02	Input	CDSREQ.941
			Output	RESPONSE.942 ISOTEDATA.943
		E-05_01	Input	CDSREQ.951
			Output	RESPONSE.952 ISOTEDATA.953
		E-05_02	Input	CDSREQ.961
			Output	RESPONSE.962 ISOTEDATA.963
ID Results	Notification about evaluation	E-07_01	Input	CDSREQ-VDT.961
			Output	RESPONSE-VDT.962 ISOTEDATA-VDT.963
		E-07_02	Input	CDSREQ-VDT.571
			Output	RESPONSE-VDT.572 ISOTEDATA-VDT.573
		E-07_03	Input	CDSREQ-VDT.951
			Output	RESPONSE-VDT.952 ISOTEDATA-VDT.953
MCC Details	Notification of MCC values	E-01_02	Input	ESR.StatusRequest
			Output	EAD.AcknowledgementDocument ECAN.CapacityDocument
Own order status change	Notification about modification/creation of own order through AMQP	E-10_01	Output	ISOTEDATA-VDT.820
Change in order book	Notification about change in order book through AMQP	E-10_02	Output	ISOTEDATA-VDT.830

4.1 Common data structures

4.1.1 ISOTEDATA

ISOTEDATA structure is a generic data structure that is derived from structures used by the ISOTE system within data exchange with market participants in the Czech Republic.

The principle of using this structure in different communication scenarios is based on the specification, i.e. message code (*message-code* attribute) that determines the type/purpose of the content. Due to clarity, types of this structure are further used in the text in *ISOTEDATA.message-code* format.

DAM order structure

Order for day-ahead market represented by *ISOTEDATA* structure consists of the following parts:

- *ISOTEDATA* - contains general details relating to the entire message (message header),
- *Trade* – represents the order itself (order header),
- *ProfileData* – order blocks, stated always in a pair – once it represents amount of electricity, next time it represents the price (*profile-role* attribute specifies the type),
- *Data* – contains values for specific hours of a trading day in the meaning according to *ProfileData* type.

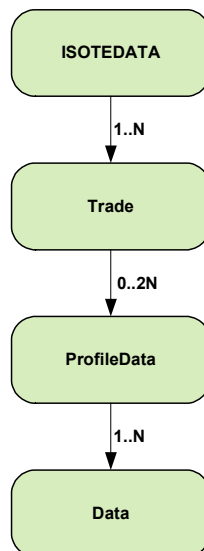

Figure 11 Scheme of order structure

ISOTEDATA

ISOTEDATA root element contains attribute values in accordance with the following table.

Table 41 **Table 42** *ISOTEDATA* root element

Attribute	Value	Description	Use
id	string	Unique message identifier within the sender system. Maximum 35 characters.	Required
message-code	number/code of the message	– It determines the purpose of structure content: – 811 – submission of order,	Required

Attribute	Value	Description	Use
		<ul style="list-style-type: none"> - 813 – description of order data (response to 811), - 833 - description of order data (response to CDSREQ.831 request). 	
date-time	YYYY-MM-DDTHH:mm:ssZ	Date and time of message sending in UTC (Universal Time): <ul style="list-style-type: none"> - YYYY – year, - MM – month, - DD – day, - HH – hour, - mm – minute, - SS – second. 	Required
answer-required	0/1	Attribute of response requirement: <ul style="list-style-type: none"> - 0 – no, - 1 – yes. 	Required

Message header contains values of particular elements in accordance with the following table.

Table 42 **Table 43** Message header of displayed values of particular elements

Element/Attribute	Value	Description	Use
Sender Identification/id	Sender EIC	Message sender identification. Entity EIC is used (it determines <i>coding-scheme=15</i> attribute). Maximum 16 characters.	Required
Receiver Identification/id	24X-OT-SK-----V	Message receiver identification. EIC = 24X-OT-SK-----V is used.	Required
Reference/id	String	Identification of related message, e.g. message involving request for own order data (it is used in responses to the message correlation).	Optional

Trade

Trade order element contains values of particular attributes in accordance with the following table.

Table 43 **Table 44** Trade order element

Attribute	Value	Description	Use
id	non-negative number	Order identification in the system (it is used in responses to the order or	Optional

Attribute	Value	Description	Use
		in the request for modification of existing order).	
version	non-negative number	Order version registered in the system (it is used in responses to the order).	Optional
trade-day	YYYY-MM-DD	Date of trading day. Date and time format: – YYYY – year, – MM – month, – DD – day.	Required
trade-type	N/P	Order class: – N – purchase (in Slovak: nákup), – P – sale (in Slovak: predaj).	Required
trade-stage	N/P	Order status in the system: – N – invalid (in Slovak: neplatný), – P – valid (in Slovak: platný), – (it is used in the response/ description of the order).	Optional
acceptance	A/N	Indicator of total acceptance of block No. 1. – A - yes, block no. 1 is accepted in whole (in Slovak: áno). – N - no, order is divisible by the time periods. In case of new form of orders this element will not be used.	Optional
block-order	A/N	Indication of block order. – A – yes, the submitted order is block. – N – no, the submitted order is a simple hourly order. Attribute is required in case of new form of orders.	Optional
block-type	SB/LB/FB/EG	Block order type. – SB – simple block order, – LB – linked block order, – FB – flexible block order, – EG – exclusive group of simple block orders. Required in case block-order = "A".	Optional

Attribute	Value	Description	Use
linked-order-id	non-negative number	Identification of linked order. Required in case block-type="LB".	Optional
sett-curr	EUR	Trading currency.	Required
market-area	SK	Trading area (SK).	Required

Trade order element contains particular elements values in accordance with the following table.

Table 44 **Table 45** Trade order element

Element/Attribute	Value	Description	Use
Party/id	Data owner EIC.	Identification of data owner on behalf of whom the data are sent. When owner of the data is sending them for himself, it is identical to SenderIdentification. Entity EIC is used. Maximum 16 characters.	Required
Party/role	TO	Role of the owner. – TO – owner of trade.	Required
Comment	string	Comment on the order.	Optional
TimeData/ datetime	YYYY-MM-DDTHH:mm:ssZ	Order timestamp in UTC (Universal Time): – YYYY – year, – MM – month, – DD – day, – HH – hour, – mm – minute, – SS – second (system generated value).	Optional
TimeData/ datetime-type	DTC	Type of timestamp: – DTC – date and time of order submission into the system (system generated value).	Optional

ProfileData

ProfileData element of order block contains values of particular attributes in accordance with the following table.

Table 45 **Table 46** ProfileData element of order block

Attribute	Value	Description	Use
profile-role	BC01 - BC25 BP01 - BP25	Determines the order and purpose of a block. BC01 - BC24: 1. - 24. block containing the amount of energy. BP01 - BP24: 1. - 24. block containing price of corresponding amount of energy. During time shift from Central European time to Central European Summer time and backwards, 23 or 25 values are used, respectively. BC01 - BC25, or BC01 - BC23 respectively. BP01 - BP23, or BP01 - BP23 respectively.	Required

ProfileData are always entered in a pair, where one element contains details on energy amounts (BC01-BC25) and the second contains the corresponding price details to amounts (BP01-BP25).

Data

Data element of data block contains values for specific hours within the day in the meaning according to block type (ProfileData/@profile-role).

Table 46 **Table 47** Data element of data block

Attribute	Value	Description	Use
period	Non-negative number	Specifies the index of hour within the day. 1...24. During time shift from Central European time to Central European Summer time and backwards, 23 or 25 values are used, respectively.	Required
value	Decimal number	Contains Amount/Price. Amount with precision to one decimal place. Price with precision to two decimal places. Separator of decimal places "." (point).	Required
unit	MWH/EUR	Data unit used in value.	Required
splitting	A/N	Divisibility – performance divisibility: – A - yes, amount is divisible (default value) (in Slovak: áno), – N - no, amount is not divisible (in Slovak: nie).	Optional

Structure of DM results and evaluations

Results of DM trading are represented by *ISOTEDATA* structure consisting of the following parts:

- *ISOTEDATA* - contains general details relating to the entire message (message header),
- *Trade* – represents DM results in a given day (result header),
- *ProfileData* – blocks of results (*profile-role* attribute specifies the type),
- *Data* – contains values for specific hours within the day with the meaning according to *ProfileData* type.

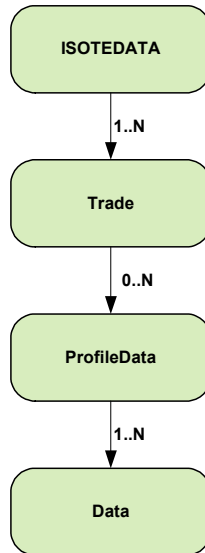

Figure 12 DM results structure scheme

ISOTEDATA

ISOTEDATA root element contains attribute values according to the following table.

Table 47 **Table 48** ISOTEDATA root element

Attribute	Value	Description	Use
id	string	Unique message identifier within the sender system. Maximum 35 characters.	Required
message-code	number/code of the message	Determines the purpose of structure content: – 943 – results per entity, – 953 – evaluation per hour, – 963 – evaluation for day.	Required
date-time	YYYY-MM-DDTHH:mm:ssZ	Date and time of message sending in UTC (Universal Time): – YYYY – year, – MM – month, – DD – day, – HH – hour, – mm – minute, – SS – second.	Required

Attribute	Value	Description	Use
answer-required	0/1	Attribute of response requirement: – 0 - no, – 1 - yes.	Required

Message header contains values of particular elements in accordance with the following table.

~~Table 48~~ **Table 49** Displayed values message header of particular elements

Element/Attribute	Value	Description	Use
Sender Identification/id	Sender EIC	Message sender identification. Entity EIC is used (it determines <i>coding-scheme=15</i> attribute). Maximum 16 characters.	Required
Receiver Identification/id	24X-OT-SK-----V	Message receiver Identification. EIC = 24X-OT-SK-----V is used.	Required
Reference/id	String	Identification of related message, e.g. the message on request for own order data (it is used in response to message correlation).	Optional

Trade

Trade element of DM result/evaluation for a given trading day contains values of particular attributes in accordance with the following table.

~~Table 49~~ **Table 50** Trade element 1 of DM result/evaluation for a given trading day

Attribute	Value	Description	Use
trade-day	YYYY-MM-DD	Date of trading day. Date and time format: – YYYY - year, – MM - month, – DD - day.	Required

Trade element of DM result/evaluation for a given trading day contains values of particular elements in accordance with the following table.

Table 50 **Table 51** Trade element 2 of DM result/evaluation for a given trading day

Element/Attribute	Value	Description	Use
Party/id	Data owner EIC	Identifier of data owner for whom the data are sent. In case of owner sending data for himself, it is identical with SenderIdentification. Entity EIC is used. Maximum 16 characters.	Required
Party/role	TO	Role of the owner: – TO - owner of trade.	Required
ResultStatus/status	P, F	Result status: – P – preliminary, – F – final. Usage of element only in case of data flows E-03_02 , E-05_01 a E-05_02 . Status of the result for already closed days before D (while D is the trading day) is by default assigned as final. Element is used only for trading days which are operated under Interim Coupling regime or during local auction resulted from this regime.	Optional

ProfileData

ProfileData element of result block contains values of particular attributes in accordance with the following table.

Table 54 **Table 52** ProfileData element of result block

Attribute	Value	Description	Use
profile-role	SP02, SC02, SP03, SC03, SP05, SC05, SC19, SP20, SC20, SP90, SC90, SP91, SC91, SP92, SC92, SP93, SC93, ST16	Specifies the meaning of result blocks. <i>Results:</i> – SC19 – amount of electricity purchased for null or positive prices (positive number), – SC20 – amount of electricity sold for null or positive prices (positive number), – SP20 – marginal price (negative, null or positive number), – SC92 – amount of electricity purchased for negative prices (positive number), – SC93 – amount of electricity sold for negative prices (positive number). <i>Evaluation:</i> – SP02 – clearing/payment for electricity purchased for null or positive prices (null or positive number), – SC02 – amount of electricity purchased for null or positive prices (positive number), – SP03 – clearing/payment for electricity sold for null or positive prices (null or positive	Required

Attribute	Value	Description	Use
		number), – SC03 – amount of electricity sold for null or positive prices (positive number), – SP05 – fee for traded electricity (positive number), – SC05 – amount of traded electricity (sum of electricity sold and purchased for positive, null and also negative prices) (positive number), – ST16 – monthly fee for access to daily market (positive number); stated in the period 0 on the last day of the month, – SP90 – fee for trading transactions relating to data manipulation (positive number), – SC90 – amount of trading transactions relating to data manipulation (positive number), – SP91 – fee for trading transactions using automated interfaces (positive number), – SC91 – amount of trading transactions using automated interfaces (positive number), – SP92 – clearing/payment for electricity purchased for negative prices (positive number), – SC92 – amount of electricity purchased for negative prices (positive number), – SP93 – clearing/payment for electricity sold for negative prices (positive number), – SC93 – amount of electricity sold for negative prices (positive number). <i>Note: payments and fees are stated excluding VAT and electricity tax</i>	

Data

Data element of data block contains values for specific hours within the day in the meaning according to block type (ProfileData/@profile-role).

Table 52 **Table 53** Data element of data block

Attribute	Value	Description	Use
period	Non-negative number	Specifies the index of hour within the day, whereas it can hold values from 1 to 24 (during time shift from Central European time to Central European Summer time and backwards, 23 or 25 periods are used, respectively). Summary daily values are stated in the period with index 0.	Required

Attribute	Value	Description	Use
value	Decimal number	In case of amount with the precision to: one decimal place. In case of price with the precision to: two decimal places. Separator of decimal places “.” (point).	Required
unit	MWH, EUR	Unit of amount stated in values.	Required

IDA order structure

Order for intraday auction represented by *ISOTEDATA* structure consists of the following parts:

- *ISOTEDATA* - contains general details relating to the entire message (message header),
- *Trade* – represents the order itself (order header),
- *ProfileData* – order blocks, stated always in a pair – once it represents amount of electricity, next time it represents the price (*profile-role* attribute specifies the type),
- *Data* – contains values for specific hours of a trading day in the meaning according to *ProfileData* type.

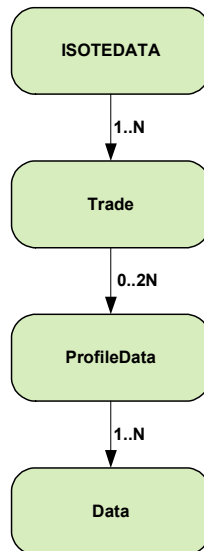

Figure 13 Scheme of order structure

ISOTEDATA

ISOTEDATA root element contains attribute values in accordance with the following table.

Table 53 Table 54 ISOTEDATA root element

Attribute	Value	Description	Use
id	string	Unique message identifier within the sender system. Maximum 35 characters.	Required
message-code	number/code of the message	– It determines the purpose of structure content:	Required

Attribute	Value	Description	Use
		<ul style="list-style-type: none"> - 851 – submission of order, - 813 – description of order data (response to 851), - 833 – description of order data (response to CDSREQ.831 request). 	
date-time	YYYY-MM-DDTHH:mm:ssZ	Date and time of message sending in UTC (Universal Time): <ul style="list-style-type: none"> - YYYY – year, - MM – month, - DD – day, - HH – hour, - mm – minute, - SS – second. 	Required
answer-required	0/1	Attribute of response requirement: <ul style="list-style-type: none"> - 0 – no, - 1 – yes. 	Required

Message header contains values of particular elements in accordance with the following table.

Table 54 **Table 55** Message header of displayed values of particular elements

Element/Attribute	Value	Description	Use
Sender Identification/id	Sender EIC	Message sender identification. Entity EIC is used (it determines <i>coding-scheme=15</i> attribute). Maximum 16 characters.	Required
Receiver Identification/id	24X-OT-SK-----V	Message receiver identification. EIC = 24X-OT-SK-----V is used.	Required
Reference/id	String	Identification of related message, e.g. message involving request for own order data (it is used in responses to the message correlation).	Optional

Trade

Trade order element contains values of particular attributes in accordance with the following table.

Table 55 **Table 56** Trade order element

Attribute	Value	Description	Use
-----------	-------	-------------	-----

Attribute	Value	Description	Use
id	non-negative number	Order identification in the system (it is used in responses to the order or in the request for modification of existing order).	Optional
version	non-negative number	Order version registered in the system (it is used in responses to the order).	Optional
trade-day	YYYY-MM-DD	Date of trading day. Date and time format: – YYYY – year, – MM – month, – DD – day.	Required
auction-id	String	IDA auction identifier: <ul style="list-style-type: none"> • IDA1 – first intraday auction for relevant trading day • IDA2 – second intraday auction for relevant trading day • IDA3 – third intraday auction for relevant trading day 	Required
trade-type	N/P	Order direction: – N – purchase (in Slovak: nákup), – P – sale (in Slovak: predaj).	Required
trade-stage	N/P	Order status in the system: – N – invalid (in Slovak: neplatný), – P – valid (in Slovak: platný), – (it is used in the response/ description of the order).	Optional
block-order	A/N	Indication of block order. – A – yes, the submitted order is block. – N – no, the submitted order is a simple hourly order. Attribute is required in case of new form of orders.	Optional
block-type	SB/LB/FB/EG	Block order type. – SB – simple block order, – LB – linked block order, – FB – flexible block order, – EG – exclusive group of simple block orders. Required in case block-order = "A".	Optional
market	IDA	Market type:	Required

Attribute	Value	Description	Use
		IDA = IDA – intraday auction	
delivery-duration	15	Duration of trading period: 15 – quarter-hour (15 min.)	Required
sett-curr	EUR	Trading currency.	Required
market-area	SK	Trading area (SK).	Required

Trade order element contains particular elements values in accordance with the following table.

Table 56 **Table 57** Trade order element

Element/Attribute	Value	Description	Use
Party/id	Data owner EIC.	Identification of data owner on behalf of whom the data are sent. When owner of the data is sending them for himself, it is identical to SenderIdentification. Entity EIC is used. Maximum 16 characters.	Required
Party/role	TO	Role of the owner. – TO – owner of trade.	Required
Comment	string	Comment on the order.	Optional
TimeData/ datetime	YYYY-MM-DDTHH:mm:ssZ	Order timestamp in UTC (Universal Time): – YYYY – year, – MM – month, – DD – day, – HH – hour, – mm – minute, – SS – second (system generated value).	Optional
TimeData/ datetime-type	DTC	Type of timestamp: – DTC – date and time of order submission into the system (system generated value).	Optional

ProfileData

ProfileData element of order block contains values of particular attributes in accordance with the following table.

Table 57 **Table 58** ProfileData element of order block

Attribute	Value	Description	Use
profile-role	BC01 - BC25 BP01 - BP25	Determines the order and purpose of a block. BC01 - BC24: 1. - 24. block containing the amount of energy. BP01 - BP24: 1. - 24. block containing price of corresponding amount of energy. During time shift from Central European time to Central European Summer time and backwards, 23 or 25 values are used, respectively. BC01 - BC25, or BC01 - BC23 respectively. BP01 - BP23, or BP01 - BP23 respectively.	Required

ProfileData are always entered in a pair, where one element contains details on energy amounts (BC01-BC25) and the second contains the corresponding price details to amounts (BP01-BP25).

Data

Data element of data block contains values for specific hours within the day in the meaning according to block type (ProfileData/@profile-role).

Table 58 **Table 59** Data element of data block

Attribute	Value	Description	Use
period	Non-negative number	Specifies the index of trading period within the day. 1...96. During time shift from Central European time to Central European Summer time and backwards, 92 or 100 values are used, respectively.	Required
value	Decimal number	Contains Amount/Price. Amount with precision to one decimal place. Price with precision to two decimal places. Separator of decimal places "." (point).	Required
unit	MW/EUR	Data unit used in value.	Required
splitting	A/N	Divisibility – performance divisibility: – A - yes, amount is divisible (default value) (in Slovak: áno), – N - no, amount is not divisible (in Slovak: nie).	Optional

Structure of IDA results and evaluations

Results of IDA trading are represented by *ISOTEDATA* structure consisting of the following parts:

- *ISOTEDATA* - contains general details relating to the entire message (message header),
- *Trade* – represents IDA results in a specific intraday auction (result header),
- *ProfileData* – blocks of results (*profile-role* attribute specifies the type),
- *Data* – contains values for specific periods within the day with the meaning according to *ProfileData* type.

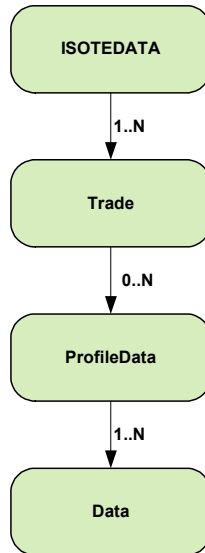

Figure 14 IDA results structure scheme

ISOTEDATA

ISOTEDATA root element contains attribute values according to the following table.

Table 59 **Table 60** ISOTEDATA root element

Attribute	Value	Description	Use
id	string	Unique message identifier within the sender system. Maximum 35 characters.	Required
message-code	number/code of the message	Determines the purpose of structure content: – 943 – results per entity, – 953 – evaluation per hour, – 963 – evaluation for day.	Required
date-time	YYYY-MM-DDTHH:mm:ssZ	Date and time of message sending in UTC (Universal Time): – YYYY – year, – MM – month, – DD – day, – HH – hour, – mm – minute, – SS – second.	Required

Attribute	Value	Description	Use
answer-required	0/1	Attribute of response requirement: – 0 - no, – 1 - yes.	Required

Message header contains values of particular elements in accordance with the following table.

~~Table 60~~ **Table 61** Displayed values message header of particular elements

Element/Attribute	Value	Description	Use
Sender Identification/id	Sender EIC	Message sender identification. Entity EIC is used (it determines <i>coding-scheme=15</i> attribute). Maximum 16 characters.	Required
Receiver Identification/id	24X-OT-SK-----V	Message receiver Identification. EIC = 24X-OT-SK-----V is used.	Required
Reference/id	String	Identification of related message, e.g. the message on request for own order data (it is used in response to message correlation).	Optional

Trade

Trade element of DM result/evaluation for a given trading day contains values of particular attributes in accordance with the following table.

~~Table 64~~ **Table 62** Trade element 1 of DM result/evaluation for a given trading day

Attribute	Value	Description	Use
trade-day	YYYY-MM-DD	Date of trading day. Date and time format: – YYYY - year, – MM - month, – DD - day.	Required
auction-id	String	IDA auction identifier: <ul style="list-style-type: none"> • IDA1 – first intraday auction for relevant trading day • IDA2 – second intraday auction for relevant trading day • IDA3 – third intraday auction for relevant trading day 	Required

Attribute	Value	Description	Use
delivery-duration	15	Duration of trading period: 15 – quarter-hour (15 min.)	Required

Trade element of IDA result/evaluation for a given trading day and auction contains values of particular elements in accordance with the following table.

Table 62 Table 63 Trade element 2 of DM result/evaluation for a given trading day

Element/Attribute	Value	Description	Use
Party/id	Data owner EIC	Identifier of data owner for whom the data are sent. In case of owner sending data for himself, it is identical with SenderIdentification. Entity EIC is used. Maximum 16 characters.	Required
Party/role	TO	Role of the owner: – TO - owner of trade.	Required
ResultStatus/status	P, F	Result status: – P – preliminary, – F – final. Usage of element only in case of data flows E-03_02 , E-05_01 a E-05_02 . Status of the result for already closed days before D (while D is the trading day) is by default assigned as final. Element is used only for trading days which are operated under Interim Coupling regime or during local auction resulted from this regime.	Optional

ProfileData

ProfileData element of result block contains values of particular attributes in accordance with the following table.

Table 63 Table 64 ProfileData element of result block

Attribute	Value	Description	Use
profile-role	SP02, SC02, SP03, SC03, SP05, SC05, SC19, SP20, SC20, SP90, SC90, SP91, SC91, SP92, SC92, SP93, SC93, ST16	Specifies the meaning of result blocks. <i>Results:</i> – SC19 – amount of electricity purchased for null or positive prices (positive number), – SC20 – amount of electricity sold for null or positive prices (positive number), – SP20 – marginal price (negative, null or positive number), – SC92 – amount of electricity purchased for negative prices (positive number), – SC93 – amount of electricity sold for negative prices (positive number). <i>Evaluation:</i> – SP02 – clearing/payment for electricity purchased for null or positive prices (null or positive number), – SC02 – amount of electricity purchased for null or positive prices (positive number), – SP03 – clearing/payment for electricity sold for null or positive prices (null or positive	Required

Attribute	Value	Description	Use
		number), – SC03 – amount of electricity sold for null or positive prices (positive number), – SP05 – fee for traded electricity (positive number), – SC05 – amount of traded electricity (sum of electricity sold and purchased for positive, null and also negative prices) (positive number), – ST16 – monthly fee for access to daily market (positive number); stated in the period 0 on the last day of the month, – SP90 – fee for trading transactions relating to data manipulation (positive number), – SC90 – amount of trading transactions relating to data manipulation (positive number), – SP91 – fee for trading transactions using automated interfaces (positive number), – SC91 – amount of trading transactions using automated interfaces (positive number), – SP92 – clearing/payment for electricity purchased for negative prices (positive number), – SC92 – amount of electricity purchased for negative prices (positive number), – SP93 – clearing/payment for electricity sold for negative prices (positive number), – SC93 – amount of electricity sold for negative prices (positive number). <i>Note: payments and fees are stated excluding VAT and electricity tax</i>	

Data

Data element of data block contains values for specific hours within the day in the meaning according to block type (ProfileData/@profile-role).

Table 64 **Table 65** Data element of data block

Attribute	Value	Description	Use
period	Non-negative number	Specifies the index of trading period within the day. 1...96. During time shift from Central European time to Central European Summer time and backwards, 92 or 100 values are used, respectively. Summary daily values are stated in the period with index 0.	Required

Attribute	Value	Description	Use
value	Decimal number	In case of amount with the precision to: three decimal places. In case of price with the precision to: two decimal places. Separator of decimal places “.” (point).	Required
unit	MWH, EUR	Unit of amount stated in values.	Required

4.1.2 ISOTEDATA-VDT

ISOTEDATA-VDT structure is common data structure used for data exchange with market participants within intraday continuous market.

The principle of using this structure in various communication scenarios resides in so-called message code (attribute message-code), with which the type/purpose of content is determined. Types of this structure due to clarity are used in text below as ISOTEDATA-VDT.message-code.

ISOTEDATA-VDT structure is used even for sending notification messages through AMQP protocol.

ISOTEDATA-VDT Structure

Order or order book description represented by ISOTEDATA-VDT structure consists of these parts:

- *ISOTEDATA* – contains common data relating to the whole message (message header),
- *Trade* – represents the order itself (order header), group of quantities/prices and last price and quantity in the case of order book data transfer,
- *ProfileData* – order blocks, always shown in pair – first time it states amount of energy and second it states the price (attribute profile-role determines the type). Except profile-role= [TC01, LC01, LP01] in case of orderbook blocks contain information such as overall and last traded quantity including last price and price direction.
- *Data* – contains the values for specific hours of trade day in meaning according to type ProfileData.

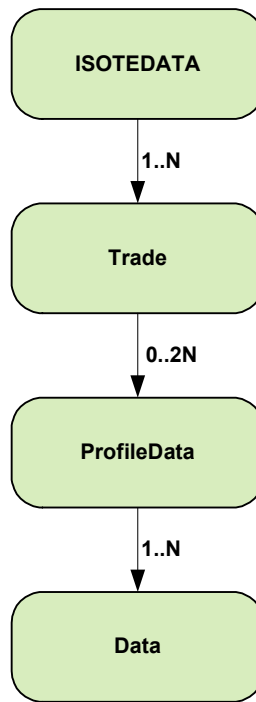

Figure 15 Scheme of order structure

ISOTEDATA-VDT

ISOTEDATA-VDT root element contains attribute values in accordance with the following table.

Table 65 ~~Table 66~~ ISOTEDATA-VDT root element

Attribute	Value	Description	Use
id	string	Unique message identifier within the sender system. Maximum 35 characters.	Required
message-code	number/code of the message	Determinates purpose of structure content: <ul style="list-style-type: none"> - 573 – monthly evaluation IDM (response to CDSREQ-VDT.571), - 801 – submission of order, - 803 – description of order data (response to ISOTEDATA-VDT.801), - 804 – order modification, - 806 - data description of modified order (response to ISOTEDATA-VDT.804), - 809 – data description of order (response to CDSREQ-VDT.807), - 812 – description of order book data (response to CDSREQ-VDT.810), - 820 – notification about status change of order through AMQP (automatically), - 830 – notification about order book status change through AMQP (automatically), - 953 – IDM evaluation per periods (response to CDSREQ-VDT.951), - 963 – daily IDM evaluation (response to CDSREQ-VDT.961). 	Required
date-time	YYYY-MM-DDTHH:mm:SSZ	Date and time of message sending in UTC (Universal Time): <ul style="list-style-type: none"> - YYYY - year, - MM - month, - DD - day, - HH - hour, - mm - minute, - SS - second. 	Required
answer-required	0/1	Attribute of response requirement. <ul style="list-style-type: none"> - 0 – no, - 1 – yes. 	Required

Message header contains values of particular elements in accordance with the following table.

~~Table 66~~ **Table 67** Message header displayed values of single elements

Attribute	Value	Description	Use
Sender Identification/id	Sender EIC	<p>Message sender identification. Depending on the direction of communication:</p> <ul style="list-style-type: none"> In direction MP -> ISOT: Entity EIC is used (determinates coding-schema=15 attribute), In direction ISOT -> MP: EIC = 24X-OT-SK-----V. <p>Maximum is 16 symbols.</p>	Required
Receiver Identification/id	Receiver EIC	<p>Message receiver. Depending on the direction of communication:</p> <ul style="list-style-type: none"> In direction MP -> ISOT: EIC = 24X-OT-SK-----V, In direction ISOT -> MP: Entity EIC (determinates coding-schema=15 attribute). <p>Maximum is 16 symbols. It is not filled in case of E-10_02 data flow.</p>	Optional
Reference/id	String	<p>Reference message identifier for example requests on data of own orders (used in responses for message correlation). Used with notification binding about change of own orders sent through AMQP protocol (data flow E-10_01).</p>	Optional

Trade

Trade element of order, contains values of single attributes in accordance with the following table.

~~Table 67~~ **Table 68** Elements of order, Trade

Attribute	Value	Description	Use
id	Non-negative number	Identifier of order in the system (used in responses to order).	Optional
version	Non-negative number	Version of order registered in the system (used in responses to order).	Optional
trade-day	YYYY-MM-DD	<p>Date of trade day. Format of date and time:</p> <ul style="list-style-type: none"> YYYY - year, MM - month, DD - day. 	Optional
trade-month	YYYY-MM	Date of month for which evaluation is provided.	Optional

Attribute	Value	Description	Use
order-expiration	YYYY-MM-DDTHH:MM:SS	Date and time of order expiration. If not stated it expires at the time of trade period closure. Format of date and time: – YYYY - year, – MM - month, – DD - day, – HH - hour, – MM - minute, – SS - second.	Optional
block-order	A/N	Attribute for block order: – A - yes, – N - no.	Required
Block-type	BL/PL/OP/V	Type of block order used only for block orders: – BL - Base Load, – PL - Peak Load, – OP - Off Peak Load, – V - User defined block.	Optional
Indication	N/FOK/IOC/AON	Identification of order: – N - no limitations, – FOK - Fill or Kill, – IOC - Immediate or Cancel, – AON - All or None – only for user-defined block orders.	Required
trade-type	N/P	Class of order: – N - buy, – P - sell.	Required
trade-stage	N/P	Status of order in the system: – N - inactive, – P - active, – C - partially traded, – S - completely traded, – E - expired, – R - expired inactive, – Z - cancelled.	Optional
trader-id	Non-negative number	Anonymous identifier of market participant. Used in data flows E-06_03 and E-10_01 .	Optional
delivery-duration	Non-negative number	Product type (period length in minutes): 60 – hourly product 15 – quarter-hourly product	Optional
sett-curr	EUR	Trade currency.	Required
market-area	SK	Trade location (SK).	Required
Market	VDT	Type of market: – VDT - intraday market.	Required

Element /Attribute	Value	Description	Use
Party/id	EIC of data owner.	Identifier of data owner for whom the data are sent. In case of owner sending data for himself, it is identical with enderIdentification. Uses EIC of subject. Max. 16 symbols.	Required
Party/role	TO	Role of owner. – TO - owner of trade.	Required
Comment	string	Commentary for order.	Optional
TimeData/ datetime	YYYY-MM-DDTHH:mm:ssZ	Order timestamp in UTC (Universal Time): – YYYY - year, – MM - month, – DD - day, – HH - hour, – mm - minute, – SS - second (value is submitted by system).	Optional
TimeData/ datetime-type	DTC DTR DTO	Type of timestamp: – DTC - date and time of order input into the system, – DTR - date and time of order modification, – DTO - date and time of data access (value is submitted by system).	Optional

ProfileData

ProfileData element of order contains values of single attributes in accordance with the following table.

Table 68 **Table 69** Element of order, ProfileData

Attribute	Value	Description	Use
trade-id	string	Identifier of trade in the system (used in responses for order description or notifications about change in order status in case the order has traded quantity). Anonym ID of user-defined block order (used in responses for order book access or notifications about change in order book). It serves as an identifier for user-defined block orders with same parameters.	Optional
profile-role	BC01 BP01 TC01 TP01 AC01 AC02 LC01 LP01	Designates order and purpose of a block. BC01: block containing energy quantity. BP01: block containing price corresponding to energy quantity. TC01: block containing amount of traded energy quantity. TP01: block containing paired price (mean value in case of several prices) corresponding to amount of traded energy. AC01: available cross-border transmission capacity in the direction from exporting area to	Required

Attribute	Value	Description	Use
		importing area (IN). AC02: available cross-border transmission capacity in the opposite direction from exporting area to importing area (OUT). LC01: block containing last traded quantity within the period. LP01: block containing last price including price direction.	

ProfileData is inputted always in pair. One element contains energy quantity data (BC01) and the second corresponding prices to quantity data (BP01). Except profile-role= [TC01, LC01, LP01] in case of orderbook blocks contain information such as overall and last traded quantity including last price and price direction.

Data

Element of block data, *Data*, contains values for specific periods within day in relation to block type (ProfileData/@profile-role).

~~Table 69~~ **Table 70** Element of block data, Data

Attribute	Value	Description	Use
period-from	Non-negative number	Designates beginning of term for which the order is entered. 0...24 for 60-minutes products, 0...96 for 15-minutes products. During transition from CET to CEST and back, there are: 23, or 25 periods for 60-minutes products, 92 or 100 periods for 15-minutes products.	Optional
period-to	Non-negative number	Designates end of term for which the order is entered. 1...25 for 60-minutes products, 0...96 for 15-minutes products. During transition from CET to CEST and back, there are: 23, or 25 periods for 60-minutes products, 92 or 100 periods for 15-minutes products.	Optional
value	Decimal number	Contains quantity/price. Quantity with one decimal position precision. Price with two decimal position precision. Separator of decimal position is "." (dot).	Required
unit	MW, EUR	Unit of entered value.	Required
seq-num	Non-negative number	Sequence number of records about quantity for given price and period. Used within message for order book data access. (data flow E-08_01 and E-10_02).	Optional

Attribute	Value	Description	Use
price-direction	N, I, D	Price direction: N=stagnant, I=increasing, D=decreasing.	Optional

4.1.3 RESPONSE

RESPONSE structure, derived from the IS OTE system, is used in communication scenarios for confirmation of transaction success during data exchange in *ISOTEDATA* structures.

The so-called message type (message-code attribute) determines the meaning of content, similarly to *ISOTEDATA*. Due to clarity, specific structure types are further used in *RESPONSE.message-code* format.

RESPONSE structure

Response is represented by *RESPONSE* structure consisting of the following parts:

- *RESPONSE* - contains general details relating to the entire message (message header),
- *Reason* – represents reason/response of request processing.

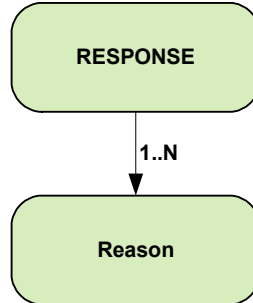

Figure 16 Scheme of RESPONSE structure

RESPONSE

RESPONSE root element contains attribute values according to the following table.

Table 70 Table 71 RESPONSE root element

Attribute	Value	Description	Use
id	string	Unique message identifier within the sender system. Maximum 35 characters.	Required
message-code	number/code of the message	Determines the purpose of structure content: <ul style="list-style-type: none"> – 812 - error/confirmation at submission/replacement of order on DM (E-02_01), – 832 - error/confirmation at sending of request for retrieval of order status on DM (E-02_03), – 942 - error/confirmation at sending of request for data – DM results (E-03_02), – 952 - error/confirmation at sending of request for data – evaluation per hours (E-05_01), – 962 - error/confirmation at sending of request for data – evaluation for day (E-05_02). 	Required
date-time	YYYY-MM-DDTHH:mm:ssZ	Date and time of message sending in UTC (Universal Time): <ul style="list-style-type: none"> – YYYY - year, – MM - month, – DD - day, – HH - hour, – mm - minute, – SS - second. 	Required

Message header contains values of particular elements in accordance with the following table.

~~Table 71~~ **Table 72** Message header of displayed values of particular elements

Element /Attribute	Value	Description	Use
Sender Identification/id	24X-OT-SK----- V	Message sender identification. EIC = 24X-OT-SK-----V is used.	Required
Receiver Identification/id	Receiver EIC	Message receiver identification. Entity EIC is used (it determines <i>coding-scheme=15</i> attribute). Maximum 16 characters.	Required
Reference/id	String	Identification of related message, for which the response is given.	Optional

REASON

Reason element contains attribute values according to the following table.

~~Table 72~~ **Table 73** Reason element

Attribute	Value	Description	Use
code	String	Detailed reason/code of response: <ul style="list-style-type: none"> -1 – Nonexistence of details, 0 – Not specified, 1 – Noncompliance with ascending/descending price development of blocks, 2 - Maximal number of blocks exceeded, 3 – Noncompliance with condition for divisibility of the first block, 4 – Noncompliance with permitted minimal and maximal amount, 5 - Noncompliance with permitted minimal and maximal price, 6 – Noncompliance with requested resolution, 7 – Noncompliance with input of amount and price in at least one hour of block, 8 – Noncompliance with paired input of details, 9 – Insufficient financial security towards clearing agent, 10 – Insufficient financial security towards market organizer. 	Required
type	AXY	Type of response: <ul style="list-style-type: none"> A01 – Rejection due to syntax error, A02 – Rejection due to application reasons, A03 – Acceptance without reservation, A04 – Acceptance with reservation 	Required
trade-id	Non-negative number	Order identification registered in the system.	Optional

Attribute	Value	Description	Use
version	Non-negative number	Order version registered in the system.	Optional

4.1.4 RESPONSE-VDT

RESPONSE-VDT structure, derived from the IS OTE system, is used in communication scenarios for confirmation of transaction success during data exchange in *ISOTEDATA-VDT* structures.

The so-called message type (message-code attribute) determines the meaning of content, similarly to *ISOTEDATA-VDT*. Due to clarity, specific structure types are in *RESPONSE-VDT.message-code* format.

RESPONSE-VDT structure

Response is represented by *RESPONSE-VDT* structure consisting of the following parts:

- *RESPONSE* - contains general details relating to the entire message (message header),
- *Reason* – represents reason/response of request processing.

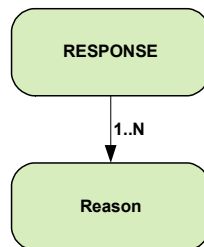

Figure 17 Scheme of RESPONSE-VDT structure

RESPONSE

RESPONSE root element contains attribute values in accordance with the following table.

Table 73 Table 74 Root element RESPONSE

Attribute	Value	Description	Use
id	string	Unique message identifier within the sender system. Maximum 35 characters.	Required
message-code	number/code of message	Determines the purpose of structure content: <ul style="list-style-type: none"> • 572 – error/confirmation after data request – results for month (E-07_02), • 802 – error/confirmation after order submission to IDM (E-06_01), • 805 – error/confirmation after IDM order modification (E-06_02), • 808 – error/confirmation after IDM order data provision request (E-06_03), • 811 – error/confirmation after order book provision request (E-08_01), • 952 – error/confirmation after results per periods data request (E-07_03), • 962 – error/confirmation after results for day data request (E-07_01). 	Required

Attribute	Value	Description	Use
date-time	YYYY-MM-DDTHH:mm:ssZ	Date and time of message sending in UTC (Universal Time): <ul style="list-style-type: none"> • YYYY – year, • MM – month, • DD – day, • HH – hour, • mm – minute, • SS – second. 	Required

Message header contains values of particular elements in accordance with the following table.

Table 74 **Table 75** Message header of displayed values of particular elements

Element /Attribute	Value	Description	Use
Sender Identification/id	24X-OT-SK-----V	Message sender identification. EIC = 24X-OT-SK-----V is used.	Required
Receiver Identification/id	Receiver EIC	Message receiver identification. Entity EIC is used (it determines <i>coding-scheme=15</i> attribute). Maximum 16 characters.	Required
Reference/id	String	Identification of related message, for which the response is given.	Optional

REASON

Reason element contains attribute values according to the following table.

Table 75 **Table 76** Reason element

Attribute	Value	Description	Use
code	String	Detailed reason/code of response: <ul style="list-style-type: none"> • -1 – Nonexistence of details, • 0 – Not specified, • 4 – Noncompliance with permitted minimal and maximal amount, • 5 - Noncompliance with permitted minimal and maximal price, • 8 – Noncompliance with paired input of details, • 9 – Insufficient financial security towards clearing agent, • 10 – Insufficient financial security towards market organizer, • 11- Incorrect combination of order parameters, • 12- Validity of order after given time period closure, • 13-Order submission for close trade period. 	Required

Attribute	Value	Description	Use
type	AXY	Type of response: <ul style="list-style-type: none"> • A01 – Rejection due to syntax error, • A02 – Rejection due to application reasons, • A03 – Acceptance without reservation, • A04 – Acceptance with reservation. 	Required
trade-id	Non-negative number	Order identification registered in the system.	Optional
version	Non-negative number	Order version registered in the system.	Optional

4.1.5 CDSREQ

CDSREQ structure, derived from the IS OTE system, is used in communication scenarios for data retrieval from the ISOT system in *ISOTEDATA* structures.

The meaning of content, i.e. the type of requested data is determined by so-called message type (*message-code* attribute) that is further used in the text in *CDSREQ.message-code* format due to clarity.

CDSREQ structure

Data request represented by *CDSREQ* structure consists of the following parts:

- *CDSREQ* - contains general details relating to the entire message (message header),
- *Trade* – identification of requested data.

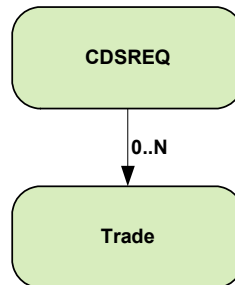

Figure 18 Scheme of CDSREQ structure

CDSREQ

CDSREQ root element contains attribute values according to the following table.

~~Table 76~~ **Table 77** *CDSREQ* root element

Attribute	Value	Description	Use
Id	string	Unique message identifier within the sender system. Maximum 35 characters.	Required

Attribute	Value	Description	Use
message-code	number/code of the message	It determines the purpose of structure content: <ul style="list-style-type: none"> • 831 – Request for data on own order (retrieval of status), • 941 – Request for DM results for subject of settlement, • 951 – Request for DM evaluation per hours, • 961 – Request for DM evaluation for day. 	Required
date-time	YYYY-MM-DDTHH:mm:SSZ	Date and time of message sending in UTC (Universal Time): <ul style="list-style-type: none"> • YYYY – year, • MM – month, • DD – day, • HH – hour, • mm – minute, • SS – second. 	Required

Message header contains values of particular elements according to the following table.

~~Table 77~~ **Table 78** Message header of displayed values of particular elements

Element /Attribute	Value	Description	Use
Sender Identification/id	Sender EIC	Message sender identification. Entity EIC is used (it determines <i>coding-scheme=15</i> attribute). Maximum 16 characters.	Required
Receiver Identification/id	24X-OT-SK-----V	Message receiver identification. EIC = 24X-OT-SK-----V is used.	Required

Trade

Trade element contains attribute values according to the following table.

~~Table 78~~ **Table 79** Trade header element

Attribute	Value	Description	Use
Id	non-negative number	Order identification in the system.	Optional
Version	non-negative number	Order version registered in the system.	Optional
trade-day	YYYY-MM-DD	Date of trading day. Date and time format: <ul style="list-style-type: none"> • YYYY – year, • MM – month, • DD – day. 	Optional

Attribute	Value	Description	Use
delivery-duration	15	Trading period duration: 15 – quarter-hour (15 min.)	Optional
auction-id	Ref'azec	IDA auction identifier: <ul style="list-style-type: none"> • IDA1 – first intraday auction for specific trading day • IDA2 – secpnd intraday auction for specific trading day • IDA3 – third intraday auction for specific trading day 	Optional

4.1.6 CDSREQ-VDT

CDSREQ structure, derived from the IS OTE system and further expanded for intraday continuous trading, is used in communication scenarios for data retrieval from the ISOT system in *ISOTEDATA-VDT* structures.

The meaning of content, i.e. the type of requested data is determined by so-called message type (*message-code* attribute) that is further used in the text in *CDSREQ-VDT.message-code* format due to clarity.

CDSREQ structure

Data request represented by *CDSREQ-VDT* structure consists of the following parts:

- *CDSREQ* - contains general details relating to the entire message (message header),
- *Trade* – identification of requested data.

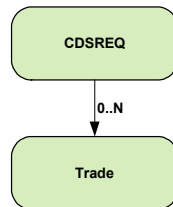

Figure 19 Scheme of CDSREQ-VDT structure

CDSREQ

CDSREQ-VDT root element contains attribute values according to the following table.

Table 79**Table 80** *CDSREQ* root element

Attribute	Value	Description	Use
Id	string	Unique message identifier within the sender system. Maximum 35 characters.	Required

Attribute	Value	Description	Use
message-code	number/code of the message	Determines the purpose of structure content: <ul style="list-style-type: none"> • 571 - Request for IDM evaluation for month (E-07_02), • 807 - Request for order data access, • 810 - Request for order book access (E-08_01), • 951 – Request for IDM evaluation per periods (E-07_03), • 961 – Request for IDM evaluation for day (E-07_01). 	Required
date-time	YYYY-MM-DDTHH:mm:ssZ	Date and time of message sending in UTC (Universal Time): <ul style="list-style-type: none"> • YYYY – year, • MM – month, • DD – day, • HH – hour, • mm – minute, • SS – second. 	Required

Message header contains values of particular elements according to the following table.

Table 80 **Table 81** Message header of displayed values of particular elements

Element /Attribute	Value	Description	Use
Sender Identification/id	Sender EIC	Message sender identification. Entity EIC is used (it determines <i>coding-scheme=15</i> attribute). Maximum 16 characters.	Required
Receiver Identification/id	24X-OT-SK-----V	Message receiver identification. EIC = 24X-OT-SK-----V is used.	Required

Trade

Element Trade contains values of particular elements according to the following table.

Table 82 Trade header element

Attribute	Value	Description	Use
id	non-negative number	Order identification on the system	Optional
version	non-negative number	Order version registered in the system	Optional
trade-day	YYYY-MM-DD	Date of trading day. Date and time format: <ul style="list-style-type: none"> • YYYY – year, • MM - month, • DD – day. 	Optional
trade-month	YYYY-MM	Date of trading month. Date and time format: <ul style="list-style-type: none"> • YYYY – year, • MM – month. 	Optional
period-from	non-negative number	Designates the beginning of the term for which the data are accessed. 0...24 for 60-minutes products, 0...96 for 15-minutes products. During transition from CET to CEST and back, there are: 23, or 25 periods for 60-minutes products, 92 or 100 periods for 15-minutes products.	Optional
period-to	non-negative number	Designates the end of the term for which the data are accessed. 1...25 (during transition from CET to CEST and back, there are 23, or 25 periods).	Optional
delivery-duration	non-negative number	Product type (period length in minutes): 60 – hourly product 15 – quarter-hourly product	Optional

4.2 Administration of DAM orders

Market participant DAM order administration is carried out through operations of order reception and availability registered in ISOT via [Orders](#) web service.

4.2.1 Processing level

Market participants enter their orders into ISOT by the deadline for order registration at the latest (during D-1). Orders can be entered into the system in advance, even several days in advance.

Market participant can register unlimited number of sale orders and unlimited number of purchase orders for a single trading day. Order can contain following characteristics:

- Standard hourly order (order containing maximum of 25 blocks without the possibility to define total acceptance of block no. 1). This order type is defined by element *block-order="N"*.
- Block order with one of the following types:
 - simple profile block order with possibility to fill up one block containing the quantity for maximum of 24 (23/25 in case of clock change day) periods with definition of one weighted-average price, defined by *block-order="A"* a *block-type="SB"*,
 - linked block order with possibility to defined parent simple block order, which must be accepted in order to trade the linked block order, defined by *block-order="A"*, *block-type="LB"* and *linked-order-id="nnnnnn"*,
 - flexible hourly block order with definition of price and quantity for one trading period, which will be selected by the matching algorithm according to matching rules, defined by *block-order="A"* and *block-type="FB"*,
 - exclusive group of block orders with possibility to submit at least 2 and maximum 8 simple block orders, where only one order may be accepted according to matching rules, defined by *block-order="A"* and *block-type="EG"*. Relevant orders within the group are submitted as separate blocks within the order.

In the case that market participant, using the modification of existing order, replaces already existing order, or removes the order from the system, it is not allowed to return to the previous version of the order i.e. not even in case that the original order was valid and the new order is invalid.

In case of invalid order, user is required to remove reasons for its invalidity by replacement with a new version or by deleting the existing order and creation of new one respectively. Orders non-compliant with the check at submission (invalid) shall be removed and will not enter the matching process.

Removal of already entered and accepted orders is carried out through submission of a new order with null values in the first block (paired values of amount/price).

4.2.2 Reception of orders (E-02_01)

Reception of orders is carried out by request for order submission in *ISOTEDATA.811* structure (message-code=811) and by response in *RESPONSE.812* structure (indication of success/fail) and *ISOTEDATA.813* structure (description of order registered in the system).

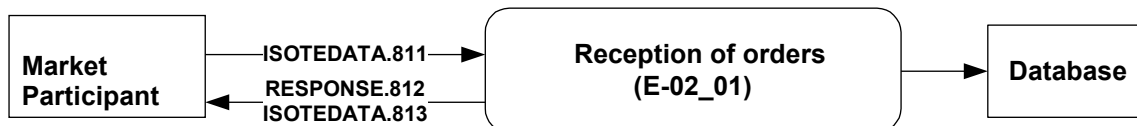

Figure 20 Scheme of DAM order reception

ISOTEDATA.811

The structure contains message-code=811 attribute in the header and is filled out in accordance with [order structure](#). Only a single order can be concurrently entered, i.e. submission of multiple orders is carried out through multiple calls.

```

<ISOTEDATA id="1" message-code="811" date-time="2009-06-20T00:00:00" dtd-version="1" dtd-
release="1" answer-required="false"
xmlns="http://sfera.sk/ws/xmtrade/isot/interfaces/orders/types/2009/04/01">
  <SenderIdentification id="24X-ENTRADE-SK-9" coding-scheme="15" />
  <ReceiverIdentification id="24X-OT-SK-----V" coding-scheme="15" />
  <Trade trade-day="2009-09-21" trade-type="P" block-order="N" market-area="SK" sett-
curr="EUR">
    <ProfileData profile-role="BC01">
      <Data period="1" value="100.0" unit="MWH" splitting="A" />
      <Data period="2" value="100.0" unit="MWH" splitting="A" />
      <Data period="3" value="100.0" unit="MWH" splitting="A" />
      <Data period="4" value="100.0" unit="MWH" splitting="A" />
      <Data period="5" value="100.0" unit="MWH" splitting="A" />
      <Data period="6" value="100.0" unit="MWH" splitting="N" />
      <Data period="7" value="100.0" unit="MWH" splitting="N" />
      <Data period="8" value="100.0" unit="MWH" splitting="N" />
      <Data period="9" value="100.0" unit="MWH" splitting="N" />
      <Data period="10" value="100.0" unit="MWH" splitting="N" />
    </ProfileData>
    <ProfileData profile-role="BP01">
      <Data period="1" value="15.00" unit="EUR" splitting="A" />
      <Data period="2" value="15.00" unit="EUR" splitting="A" />
      <Data period="3" value="15.00" unit="EUR" splitting="A" />
      <Data period="4" value="15.00" unit="EUR" splitting="A" />
      <Data period="5" value="15.00" unit="EUR" splitting="A" />
      <Data period="6" value="15.00" unit="EUR" splitting="N" />
      <Data period="7" value="15.00" unit="EUR" splitting="N" />
      <Data period="8" value="15.00" unit="EUR" splitting="N" />
      <Data period="9" value="15.00" unit="EUR" splitting="N" />
      <Data period="10" value="15.00" unit="EUR" splitting="N" />
    </ProfileData>
    <Party id="24X-ENTRADE-SK-9" role="TO" />
  </Trade>
</ISOTEDATA>

```

Example 1 Submission of standard hourly sale order

```

<ISOTEDATA id="1" message-code="811" date-time="2009-06-20T00:00:00" dtd-version="1" dtd-
release="1" answer-required="false"
xmlns="http://sfera.sk/ws/xmtrade/isot/interfaces/orders/types/2009/04/01">
  <SenderIdentification id="24X-ENTRADE-SK-9" coding-scheme="15" />
  <ReceiverIdentification id="24X-OT-SK-----V" coding-scheme="15" />
  <Trade trade-day="2009-09-21" trade-type="P" block-order="A" block-type="SB" market-
area="SK" sett-curr="EUR">
    <ProfileData profile-role="BC01">
      <Data period="1" value="100.0" unit="MWH" splitting="A" />
      <Data period="2" value="100.0" unit="MWH" splitting="A" />
      <Data period="3" value="100.0" unit="MWH" splitting="A" />
      <Data period="4" value="100.0" unit="MWH" splitting="A" />
      <Data period="5" value="100.0" unit="MWH" splitting="A" />
      <Data period="6" value="100.0" unit="MWH" splitting="N" />
      <Data period="7" value="100.0" unit="MWH" splitting="N" />
      <Data period="8" value="100.0" unit="MWH" splitting="N" />
      <Data period="9" value="100.0" unit="MWH" splitting="N" />
      <Data period="10" value="100.0" unit="MWH" splitting="N" />
    </ProfileData>
    <ProfileData profile-role="BP01">
      <Data period="1" value="15.00" unit="EUR" splitting="A" />
      <Data period="2" value="15.00" unit="EUR" splitting="A" />
      <Data period="3" value="15.00" unit="EUR" splitting="A" />
      <Data period="4" value="15.00" unit="EUR" splitting="A" />
      <Data period="5" value="15.00" unit="EUR" splitting="A" />
      <Data period="6" value="15.00" unit="EUR" splitting="N" />
      <Data period="7" value="15.00" unit="EUR" splitting="N" />
      <Data period="8" value="15.00" unit="EUR" splitting="N" />
      <Data period="9" value="15.00" unit="EUR" splitting="N" />
      <Data period="10" value="15.00" unit="EUR" splitting="N" />
    </ProfileData>
    <Party id="24X-ENTRADE-SK-9" role="TO" />
  </Trade>
</ISOTEDATA>

```

Example 2 Submission of simple block sale order

RESPONSE.812

In case of successful or failed order processing, response is returned in accordance with specification of [RESPONSE](#) structure, with *message-code=812* in the header. Identification, under which the order is registered in the system, is returned in *Reason/@trade-id* attribute.

```
<RESPONSE id="cb4d980f-2f9a-4be7-96ef-850be04b214" message-code="812"
  date-time="2009-07-03T13:46:26Z" dtd-version="1" dtd-release="1"
  xmlns="http://sfera.sk/ws/xmtrade/isot/interfaces/ut/types/2009/04/01">
  <SenderIdentification id="24X-OT-SK-----V" coding-scheme="15" />
  <ReceiverIdentification id="24X-ENTRADE-SK-9" coding-scheme="15" />
  <Reference id="1"/>
  <Reason code="0" type="A03" trade-id="1016"/>
</RESPONSE>
```

Example 3 Response on success of order submission**ISOTEDATA.813**

In case of successful order processing, the structure is returned as it was registered in the system, where *message-code=813* can be found in the header. Identification and version, under which the order is registered in the system, are returned in *Trade/@id* and *Trade/@version* attribute. Own order data can be retrieved back based on this identification (see E-02_03).

```
<ISOTEDATA id="ac5e799q-2qtr-75e7-9bef-8aabc02b7f4" message-code="813"
  date-time="2009-07-03T13:46:26Z" dtd-version="1" dtd-release="1" answer-
  required="false"
  xmlns="http://sfera.sk/ws/xmtrade/isot/interfaces/orders/types/2009/04/01">
  <SenderIdentification id="24X-ENTRADE-SK-9" coding-scheme="15"/>
  <ReceiverIdentification id="24X-OT-SK-----V" coding-scheme="15" />
  <Reference id="1"/>
  <Trade id="1016" trade-day="2009-09-21" version="1" trade-type="P" block-order="N" trade-
  stage="P" sett-curr="EUR" market-area="SK">
  <TimeData datetime="2009-07-03T13:46:26Z" datetime-type="DTC"/>
  <ProfileData profile-role="BC01">
  <Data period="1" value="100.0" unit="MWH" splitting="A"/>
  <Data period="2" value="100.0" unit="MWH" splitting="A"/>
  <Data period="3" value="100.0" unit="MWH" splitting="A"/>
  <Data period="4" value="100.0" unit="MWH" splitting="A"/>
  <Data period="5" value="100.0" unit="MWH" splitting="A"/>
  <Data period="6" value="100.0" unit="MWH" splitting="N"/>
  <Data period="7" value="100.0" unit="MWH" splitting="N"/>
  <Data period="8" value="100.0" unit="MWH" splitting="N"/>
  <Data period="9" value="100.0" unit="MWH" splitting="N"/>
  <Data period="10" value="100.0" unit="MWH" splitting="N"/>
  </ProfileData>
  <ProfileData profile-role="BP01">
  <Data period="1" value="15.00" unit="EUR" splitting="A"/>
  <Data period="2" value="15.00" unit="EUR" splitting="A"/>
  <Data period="3" value="15.00" unit="EUR" splitting="A"/>
  <Data period="4" value="15.00" unit="EUR" splitting="A"/>
  <Data period="5" value="15.00" unit="EUR" splitting="A"/>
  <Data period="6" value="15.00" unit="EUR" splitting="N"/>
  <Data period="7" value="15.00" unit="EUR" splitting="N"/>
  <Data period="8" value="15.00" unit="EUR" splitting="N"/>
  <Data period="9" value="15.00" unit="EUR" splitting="N"/>
  <Data period="10" value="15.00" unit="EUR" splitting="N"/>
  </ProfileData>
  <Party id="24X-ENTRADE-SK-9" role="TO"/>
</Trade>
</ISOTEDATA>
```

Example 4 Response with description of entered order in the system**4.2.3 Removal of orders (E-02_01)**

Removal of order is carried out by submission of specific order in *ISOTEDATA.811* structure (message-code=811) containing null values for amount and price in the first block for all periods of a given trading day. Response to order removal is returned in *RESPONSE.812* structure (indication of

success/failure) and *ISOTEDATA.813* structure (description of order that was removed from the system).



Figure 21 Scheme of market participant order removal

ISOTEDATA.811

The structure contains *message-code=811* attribute in the header and is filled out in accordance with [order structure](#) specification, where only the 1. block is entered containing null values for amount and price. Request can be entered for removal of orders for specific trading day (*trade-day* attribute), removal of specific trading day and order type (*trade-day* and *trade-type* attributes) or removal of specific order via order identification of relevant order (*id* attribute returned in responses at order submission).

```

<ISOTEDATA id="1" message-code="811" date-time="2009-06-20T00:00:00" dtd-version="1" dtd-
release="1" answer-required="false"
xmlns="http://sfera.sk/ws/xmtrade/isot/interfaces/orders/types/2009/04/01">
  <SenderIdentification id="24X-ENTRADE-SK-9" coding-scheme="15" />
  <ReceiverIdentification id="24X-OT-SK-----V" coding-scheme="15" />
  <Trade id="1016" trade-day="2009-09-21" trade-type="P" market-area="SK" sett-curr="EUR">
    <ProfileData profile-role="BC01">
      <Data period="1" value="0.0" unit="MWH" splitting="A"/>
      <Data period="2" value="0.0" unit="MWH" splitting="A"/>
      <Data period="3" value="0.0" unit="MWH" splitting="A"/>
      <Data period="4" value="0.0" unit="MWH" splitting="A"/>
      <Data period="5" value="0.0" unit="MWH" splitting="A"/>
      <Data period="6" value="0.0" unit="MWH" splitting="A"/>
      <Data period="7" value="0.0" unit="MWH" splitting="A"/>
      <Data period="8" value="0.0" unit="MWH" splitting="A"/>
      <Data period="9" value="0.0" unit="MWH" splitting="A"/>
      <Data period="10" value="0.0" unit="MWH" splitting="A"/>
      <Data period="11" value="0.0" unit="MWH" splitting="A"/>
      <Data period="12" value="0.0" unit="MWH" splitting="A"/>
      <Data period="13" value="0.0" unit="MWH" splitting="A"/>
      <Data period="14" value="0.0" unit="MWH" splitting="A"/>
      <Data period="15" value="0.0" unit="MWH" splitting="A"/>
      <Data period="16" value="0.0" unit="MWH" splitting="A"/>
      <Data period="17" value="0.0" unit="MWH" splitting="A"/>
      <Data period="18" value="0.0" unit="MWH" splitting="A"/>
      <Data period="19" value="0.0" unit="MWH" splitting="A"/>
      <Data period="20" value="0.0" unit="MWH" splitting="A"/>
      <Data period="21" value="0.0" unit="MWH" splitting="A"/>
      <Data period="22" value="0.0" unit="MWH" splitting="A"/>
      <Data period="23" value="0.0" unit="MWH" splitting="A"/>
      <Data period="24" value="0.0" unit="MWH" splitting="A"/>
    </ProfileData>
    <ProfileData profile-role="BP01">
      <Data period="1" value="0.0" unit="EUR" splitting="A"/>
      <Data period="2" value="0.0" unit="EUR" splitting="A"/>
      <Data period="3" value="0.0" unit="EUR" splitting="A"/>
      <Data period="4" value="0.0" unit="EUR" splitting="A"/>
      <Data period="5" value="0.0" unit="EUR" splitting="A"/>
      <Data period="6" value="0.0" unit="EUR" splitting="A"/>
      <Data period="7" value="0.0" unit="EUR" splitting="A"/>
      <Data period="8" value="0.0" unit="EUR" splitting="A"/>
      <Data period="9" value="0.0" unit="EUR" splitting="A"/>
      <Data period="10" value="0.0" unit="EUR" splitting="A"/>
      <Data period="11" value="0.0" unit="EUR" splitting="A"/>
      <Data period="12" value="0.0" unit="EUR" splitting="A"/>
      <Data period="13" value="0.0" unit="EUR" splitting="A"/>
      <Data period="14" value="0.0" unit="EUR" splitting="A"/>
      <Data period="15" value="0.0" unit="EUR" splitting="A"/>
      <Data period="16" value="0.0" unit="EUR" splitting="A"/>
      <Data period="17" value="0.0" unit="EUR" splitting="A"/>
      <Data period="18" value="0.0" unit="EUR" splitting="A"/>
      <Data period="19" value="0.0" unit="EUR" splitting="A"/>
      <Data period="20" value="0.0" unit="EUR" splitting="A"/>
      <Data period="21" value="0.0" unit="EUR" splitting="A"/>
      <Data period="22" value="0.0" unit="EUR" splitting="A"/>
      <Data period="23" value="0.0" unit="EUR" splitting="A"/>
      <Data period="24" value="0.0" unit="EUR" splitting="A"/>
    </ProfileData>
    <Party id="24X-ENTRADE-SK-9" role="TO" />
  </Trade>
</ISOTEDATA>

```

Example 5 Removal of specific sale order

RESPONSE.812

In accordance with specification of [RESPONSE](#) structure, response is given in case of successful or unsuccessful order processing. In this case message-code=812 can be found in the header.

```
<RESPONSE id="cb4d980f-2f9a-4be7-96ef-850be04b214" message-code="812"
  date-time="2009-07-03T13:46:26Z" dtd-version="1" dtd-release="1"
  xmlns="http://sfera.sk/ws/xmtrade/isot/interfaces/ut/types/2009/04/01">
  <SenderIdentification id="24X-OT-SK-----V" coding-scheme="15" />
  <ReceiverIdentification id="24X-ENTRADE-SK-9" coding-scheme="15" />
  <Reference id="1"/>
  <Reason code="0" type="A03"/>
</RESPONSE>
```

Example 6 Response on success of order removal**ISOTEDATA.813**

In case of successful order removal, the original order that was removed from the system will be returned. Message-code=813 can be found in the header.

```
<ISOTEDATA id="ac5e799q-2qtr-75e7-9bef-8aabc02b7f4" message-code="813"
  date-time="2009-07-03T13:46:26Z" dtd-version="1" dtd-release="1" answer-
  required="false"
  xmlns="http://sfera.sk/ws/xmtrade/isot/interfaces/orders/types/2009/04/01">
  <SenderIdentification id="24X-ENTRADE-SK-9" coding-scheme="15"/>
  <ReceiverIdentification id="24X-OT-SK-----V" coding-scheme="15" />
  <Reference id="1"/>
  <Trade id="1016" trade-day="2009-09-21" version="1" trade-type="P" block-order="N" trade-
  stage="P" sett-curr="EUR" market-area="SK">
  <TimeData datetime="2009-07-03T13:46:26Z" datetime-type="DTC"/>
  <ProfileData profile-role="BC01">
  <Data period="1" value="100.0" unit="MWH" splitting="A"/>
  <Data period="2" value="100.0" unit="MWH" splitting="A"/>
  <Data period="3" value="100.0" unit="MWH" splitting="A"/>
  <Data period="4" value="100.0" unit="MWH" splitting="A"/>
  <Data period="5" value="100.0" unit="MWH" splitting="A"/>
  <Data period="6" value="100.0" unit="MWH" splitting="N"/>
  <Data period="7" value="100.0" unit="MWH" splitting="N"/>
  <Data period="8" value="100.0" unit="MWH" splitting="N"/>
  <Data period="9" value="100.0" unit="MWH" splitting="N"/>
  <Data period="10" value="100.0" unit="MWH" splitting="N"/>
  </ProfileData>
  <ProfileData profile-role="BP01">
  <Data period="1" value="15.00" unit="EUR" splitting="A"/>
  <Data period="2" value="15.00" unit="EUR" splitting="A"/>
  <Data period="3" value="15.00" unit="EUR" splitting="A"/>
  <Data period="4" value="15.00" unit="EUR" splitting="A"/>
  <Data period="5" value="15.00" unit="EUR" splitting="A"/>
  <Data period="6" value="15.00" unit="EUR" splitting="N"/>
  <Data period="7" value="15.00" unit="EUR" splitting="N"/>
  <Data period="8" value="15.00" unit="EUR" splitting="N"/>
  <Data period="9" value="15.00" unit="EUR" splitting="N"/>
  <Data period="10" value="15.00" unit="EUR" splitting="N"/>
  </ProfileData>
  <Party id="24X-ENTRADE-SK-9" role="TO"/>
  </Trade>
</ISOTEDATA>
```

Example 7 Response with description of removed order from the system**4.2.4 Order modification (E-02_01)**

Modification of order is carried out by entry of specific order that is to be modified in *ISOTEDATA.811* structure (message-code=811) containing updated values for amount and price for desired trading periods of a given trading day. Response to order removal is returned in *RESPONSE.812* structure (indication of success/failure) and *ISOTEDATA.813* structure (description of modified order saved in the system). Order header modification is not possible. In order to modify the order header (i.e. type or direction), delete the existing order and submit a new one with required parameters.



Figure 22 Scheme of market participant order modification

ISOTEDATA.811

The structure contains *message-code=811* attribute in the header and is filled out in accordance with [order structure](#) specification. The order that is to be modified must be identified by specification of its ID in the attribute *Trade/id*. Only a single order can be concurrently modified, i.e. modification of multiple orders is carried out through multiple calls.

```

<ISOTEDATA id="1" message-code="811" date-time="2009-06-20T00:00:00" dtd-version="1" dtd-
release="1" answer-required="false"
xmlns="http://sfera.sk/ws/xmtrade/isot/interfaces/orders/types/2009/04/01">
  <SenderIdentification id="24X-ENTRADE-SK-9" coding-scheme="15" />
  <ReceiverIdentification id="24X-OT-SK-----V" coding-scheme="15" />
  <Trade id="1016" trade-day="2009-09-21" trade-type="P" block-order="N" market-area="SK" sett-
curr="EUR">
    <ProfileData profile-role="BC01">
      <Data period="1" value="10.0" unit="MWH" splitting="A"/>
      <Data period="2" value="10.0" unit="MWH" splitting="A"/>
      <Data period="3" value="10.0" unit="MWH" splitting="A"/>
      <Data period="4" value="10.0" unit="MWH" splitting="A"/>
      <Data period="5" value="20.0" unit="MWH" splitting="A"/>
      <Data period="6" value="20.0" unit="MWH" splitting="A"/>
      <Data period="7" value="20.0" unit="MWH" splitting="A"/>
      <Data period="8" value="10.0" unit="MWH" splitting="A"/>
      <Data period="9" value="10.0" unit="MWH" splitting="A"/>
      <Data period="10" value="10.0" unit="MWH" splitting="A"/>
      <Data period="11" value="10.0" unit="MWH" splitting="A"/>
      <Data period="12" value="10.0" unit="MWH" splitting="A"/>
      <Data period="13" value="10.0" unit="MWH" splitting="A"/>
      <Data period="14" value="10.0" unit="MWH" splitting="A"/>
      <Data period="15" value="20.0" unit="MWH" splitting="A"/>
      <Data period="16" value="20.0" unit="MWH" splitting="A"/>
      <Data period="17" value="20.0" unit="MWH" splitting="A"/>
      <Data period="18" value="20.0" unit="MWH" splitting="A"/>
      <Data period="19" value="20.0" unit="MWH" splitting="A"/>
      <Data period="20" value="20.0" unit="MWH" splitting="A"/>
      <Data period="21" value="10.0" unit="MWH" splitting="A"/>
      <Data period="22" value="10.0" unit="MWH" splitting="A"/>
      <Data period="23" value="10.0" unit="MWH" splitting="A"/>
      <Data period="24" value="10.0" unit="MWH" splitting="A"/>
    </ProfileData>
    <ProfileData profile-role="BP01">
      <Data period="1" value="50.0" unit="EUR" splitting="A"/>
      <Data period="2" value="50.0" unit="EUR" splitting="A"/>
      <Data period="3" value="50.0" unit="EUR" splitting="A"/>
      <Data period="4" value="50.0" unit="EUR" splitting="A"/>
      <Data period="5" value="50.0" unit="EUR" splitting="A"/>
      <Data period="6" value="50.0" unit="EUR" splitting="A"/>
      <Data period="7" value="50.0" unit="EUR" splitting="A"/>
      <Data period="8" value="50.0" unit="EUR" splitting="A"/>
      <Data period="9" value="50.0" unit="EUR" splitting="A"/>
      <Data period="10" value="50.0" unit="EUR" splitting="A"/>
      <Data period="11" value="50.0" unit="EUR" splitting="A"/>
      <Data period="12" value="50.0" unit="EUR" splitting="A"/>
      <Data period="13" value="50.0" unit="EUR" splitting="A"/>
      <Data period="14" value="50.0" unit="EUR" splitting="A"/>
      <Data period="15" value="50.0" unit="EUR" splitting="A"/>
      <Data period="16" value="50.0" unit="EUR" splitting="A"/>
      <Data period="17" value="50.0" unit="EUR" splitting="A"/>
      <Data period="18" value="50.0" unit="EUR" splitting="A"/>
      <Data period="19" value="50.0" unit="EUR" splitting="A"/>
      <Data period="20" value="50.0" unit="EUR" splitting="A"/>
      <Data period="21" value="50.0" unit="EUR" splitting="A"/>
      <Data period="22" value="50.0" unit="EUR" splitting="A"/>
      <Data period="23" value="50.0" unit="EUR" splitting="A"/>
      <Data period="24" value="50.0" unit="EUR" splitting="A"/>
    </ProfileData>
    <Party id="24X-ENTRADE-SK-9" role="TO" />
  </Trade>
</ISOTEDATA>

```

Example 8 Modification of specific order

RESPONSE.812

In accordance with specification of [RESPONSE](#) structure, response is given in case of successful or unsuccessful order processing. In this case message-code=812 can be found in the header.

```
<RESPONSE id="cb4d980f-2f9a-4be7-96ef-850be04b214" message-code="812"
  date-time="2009-07-03T13:46:26Z" dtd-version="1" dtd-release="1"
  xmlns="http://sfera.sk/ws/xmtrade/isot/interfaces/ut/types/2009/04/01">
  <SenderIdentification id="24X-OT-SK-----V" coding-scheme="15" />
  <ReceiverIdentification id="24X-ENTRADE-SK-9" coding-scheme="15" />
  <Reference id="1"/>
  <Reason code="0" type="A03"/>
</RESPONSE>
```

Example 9 Response on success of order modification

ISOTEDATA.813

In case of successful order modification, the successfully modified order will be returned with increased version in comparison to original order. Message-code=813 can be found in the header.

```

<ISOTEDATA id="ac5e799q-2qtr-75e7-9bef-8aabc02b7f4" message-code="813"
  date-time="2009-07-03T13:46:26Z" dtd-version="1" dtd-release="1" answer-required="false"
  xmlns="http://sfera.sk/ws/xmtrade/isot/interfaces/orders/types/2009/04/01">
  <SenderIdentification id="24X-ENTRADE-SK-9" coding-scheme="15"/>
  <ReceiverIdentification id="24X-OT-SK-----V" coding-scheme="15" />
  <Reference id="1"/>
  <Trade id="1016" trade-day="2009-09-21" version="2" trade-type="P" block-order="N" trade-
stage="P" sett-curr="EUR" market-area="SK">
  <TimeData datetime="2009-07-03T13:46:26Z" datetime-type="DTC"/>
  <ProfileData profile-role="BC01">
    <Data period="1" value="10.0" unit="MWH" splitting="A"/>
    <Data period="2" value="10.0" unit="MWH" splitting="A"/>
    <Data period="3" value="10.0" unit="MWH" splitting="A"/>
    <Data period="4" value="10.0" unit="MWH" splitting="A"/>
    <Data period="5" value="20.0" unit="MWH" splitting="A"/>
    <Data period="6" value="20.0" unit="MWH" splitting="A"/>
    <Data period="7" value="20.0" unit="MWH" splitting="A"/>
    <Data period="8" value="10.0" unit="MWH" splitting="A"/>
    <Data period="9" value="10.0" unit="MWH" splitting="A"/>
    <Data period="10" value="10.0" unit="MWH" splitting="A"/>
    <Data period="11" value="10.0" unit="MWH" splitting="A"/>
    <Data period="12" value="10.0" unit="MWH" splitting="A"/>
    <Data period="13" value="10.0" unit="MWH" splitting="A"/>
    <Data period="14" value="10.0" unit="MWH" splitting="A"/>
    <Data period="15" value="20.0" unit="MWH" splitting="A"/>
    <Data period="16" value="20.0" unit="MWH" splitting="A"/>
    <Data period="17" value="20.0" unit="MWH" splitting="A"/>
    <Data period="18" value="20.0" unit="MWH" splitting="A"/>
    <Data period="19" value="20.0" unit="MWH" splitting="A"/>
    <Data period="20" value="20.0" unit="MWH" splitting="A"/>
    <Data period="21" value="10.0" unit="MWH" splitting="A"/>
    <Data period="22" value="10.0" unit="MWH" splitting="A"/>
    <Data period="23" value="10.0" unit="MWH" splitting="A"/>
    <Data period="24" value="10.0" unit="MWH" splitting="A"/>
  </ProfileData>
  <ProfileData profile-role="BP01">
    <Data period="1" value="50.0" unit="EUR" splitting="A"/>
    <Data period="2" value="50.0" unit="EUR" splitting="A"/>
    <Data period="3" value="50.0" unit="EUR" splitting="A"/>
    <Data period="4" value="50.0" unit="EUR" splitting="A"/>
    <Data period="5" value="50.0" unit="EUR" splitting="A"/>
    <Data period="6" value="50.0" unit="EUR" splitting="A"/>
    <Data period="7" value="50.0" unit="EUR" splitting="A"/>
    <Data period="8" value="50.0" unit="EUR" splitting="A"/>
    <Data period="9" value="50.0" unit="EUR" splitting="A"/>
    <Data period="10" value="50.0" unit="EUR" splitting="A"/>
    <Data period="11" value="50.0" unit="EUR" splitting="A"/>
    <Data period="12" value="50.0" unit="EUR" splitting="A"/>
    <Data period="13" value="50.0" unit="EUR" splitting="A"/>
    <Data period="14" value="50.0" unit="EUR" splitting="A"/>
    <Data period="15" value="50.0" unit="EUR" splitting="A"/>
    <Data period="16" value="50.0" unit="EUR" splitting="A"/>
    <Data period="17" value="50.0" unit="EUR" splitting="A"/>
    <Data period="18" value="50.0" unit="EUR" splitting="A"/>
    <Data period="19" value="50.0" unit="EUR" splitting="A"/>
    <Data period="20" value="50.0" unit="EUR" splitting="A"/>
    <Data period="21" value="50.0" unit="EUR" splitting="A"/>
    <Data period="22" value="50.0" unit="EUR" splitting="A"/>
    <Data period="23" value="50.0" unit="EUR" splitting="A"/>
    <Data period="24" value="50.0" unit="EUR" splitting="A"/>
  </ProfileData>
  <Party id="24X-ENTRADE-SK-9" role="TO"/>
</Trade>
</ISOTEDATA>

```

Example 10 Response with description of modified order

4.2.5 Provision of orders (E-02_03)

Provision of orders is carried out by request for order retrieval in *CDSREQ.831* structure (message-code=831) and response in *RESPONSE.832* structure (indication of success/failure) and *ISOTEDATA.833* structure (description of order registered in the system).

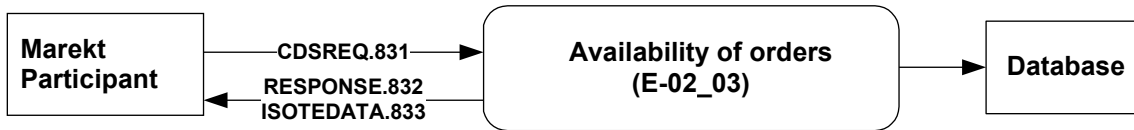

Figure 23 Scheme of market participant order provision

CDSREQ.831

Request can be formulated either for specific trading day (trade-day) or for specific order (id and version) and is filled out according to the specification of [CDSREQ](#) structure. Order identification has precedence over trading day.

```

<CDSREQ id="4a6s5d45f" message-code="831" date-time="2014-09-19T01:18:33" dtd-version="1"
dtd-release="1" xmlns="http://sfera.sk/ws/xmtrade/isot/interfaces/ut/types/2009/04/01">
  <SenderIdentification id="11XKORLEAINVESTY" coding-scheme="15"/>
  <ReceiverIdentification id="24X-OT-SK-----V" coding-scheme="15"/>
  <Trade trade-day="2009-09-21"/>
</CDSREQ>
  
```

Example 11 Request for retrieval of orders for specific day

RESPONSE.832

In case of successful or failed request processing, response is returned in accordance with specification of [RESPONSE](#) structure, where message-code=832 can be found in the header.

```

<RESPONSE id="a9e40366-ad70-45ac-8b36-bd8fbce5ef7" message-code="832"
date-time="2009-07-03T14:02:36Z" dtd-version="1" dtd-release="1"
xmlns="http://sfera.sk/ws/xmtrade/isot/interfaces/ut/types/2009/04/01">
  <SenderIdentification id="24X-OT-SK-----V" coding-scheme="15"/>
  <ReceiverIdentification id="11XKORLEAINVESTY" coding-scheme="15" />
  <Reference id="4a6s5d45f"/>
  <Reason code="0" type="A03"/>
</RESPONSE>
  
```

Example 12 Response on success of order provision for specific day

ISOTEDATA.833

In case of successful request processing, the structure is returned as it was registered in the system and message-code=833 can be found in the header. Identification and version, under which the order is registered in the system, are returned in *Trade/@id* and *Trade/@version* attribute. If there is a single purchase order and a single sale order registered in the system for a given trading day, return structure of request for specific trading day contains two orders (either valid or invalid).

```
<ISOTEDATA id="1" message-code="833" date-time="2009-07-03T14:02:36Z"
  dtd-version="1" dtd-release="1" answer-required="false"
  xmlns="http://sfera.sk/ws/xmtrade/isot/interfaces/orders/types/2009/04/01">
  <SenderIdentification id="11XKORLEAINVESTY" coding-scheme="15"/>
  <ReceiverIdentification id="24X-OT-SK-----V" coding-scheme="15"/>
  <Reference id="4a6s5d45f"/>
  <Trade id="977" trade-day="2009-09-21" trade-type="P" block-order="N" trade-stage="P"
    sett-curr="EUR" market-area="SK">
    <TimeData datetime="2009-07-02T09:00:43Z" datetime-type="DTC"/>
    <ProfileData profile-role="BC01">
      <Data period="1" value="5.0" unit="MWH" splitting="A"/>
      <Data period="2" value="5.0" unit="MWH" splitting="A"/>
      <Data period="3" value="5.0" unit="MWH" splitting="A"/>
      <Data period="4" value="5.0" unit="MWH" splitting="A"/>
      <Data period="5" value="5.0" unit="MWH" splitting="A"/>
      <Data period="6" value="5.0" unit="MWH" splitting="A"/>
      <Data period="7" value="5.0" unit="MWH" splitting="A"/>
      <Data period="8" value="5.0" unit="MWH" splitting="A"/>
      <Data period="9" value="5.0" unit="MWH" splitting="A"/>
      <Data period="10" value="5.0" unit="MWH" splitting="A"/>
    </ProfileData>
    <ProfileData profile-role="BP01">
      <Data period="1" value="24.00" unit="EUR" splitting="A"/>
      <Data period="2" value="24.00" unit="EUR" splitting="A"/>
      <Data period="3" value="24.00" unit="EUR" splitting="A"/>
      <Data period="4" value="24.00" unit="EUR" splitting="A"/>
      <Data period="5" value="24.00" unit="EUR" splitting="A"/>
      <Data period="6" value="24.00" unit="EUR" splitting="A"/>
      <Data period="7" value="24.00" unit="EUR" splitting="A"/>
      <Data period="8" value="24.00" unit="EUR" splitting="A"/>
      <Data period="9" value="24.00" unit="EUR" splitting="A"/>
      <Data period="10" value="24.00" unit="EUR" splitting="A"/>
    </ProfileData>
    <Party id="11XKORLEAINVESTY" role="TO"/>
  </Trade>
</ISOTEDATA>
```

Example 13 Response containing orders for specific day

4.3 Administration of Intraday Market orders

Administration of orders of market participants is carried out through operations for order reception, order modification and order provision via [ldmOrders](#) web service at Intraday Market.

4.3.1 Processing level

Market participants enter their orders into ISOT by the deadline for given trading hour, where orders can be entered into the system in advance, even for more trading time periods if they are open. Opening of trading hour for next day begins at 3 p.m. every day.

In case of invalid order, user is required to remove reasons for its invalidity by replacing it with a new version. Orders non-compliant with the check at submission (invalid) shall be removed and will not enter the matching process.

Depending on date of transition from domestic intraday market to coordinated cross-border intraday market under the SIDC (Single Intraday Coupling) project, products used within the intraday market will be changed according to the following:

- 60-minutes products:
 - simple orders for 1 period,
 - Block orders,
 - predefined (base/peak/off-peak) – submission **will not be** supported,
 - user-defined (own blocks) – zadávanie **will be** supported.
- 15-minutes products:
 - simple orders for 1 period.

In regards to change of products in relation to length of the trading period, messages under ISOTEDATA-VDT will use following definition of trading periods:

Length of product period					
60-minutes			15-minutes		
Period	Period from	Period to	Period	Period from	Period to
00:00 – 01:00	0	1	00:00 – 00:15	0	1
			00:15 – 00:30	1	2
			00:30 – 00:45	2	3
			00:45 – 01:00	3	4
01:00 – 02:00	1	2	01:00 – 01:15	4	5
			01:15 – 01:30	5	6
			01:30 – 01:45	6	7
			01:45 – 02:00	7	8
02:00 – 03:00	2	3	02:00 – 02:15	8	9
			02:15 – 02:30	9	10
			02:30 – 02:45	10	11
			02:45 – 03:00	11	12

Length of product period					
60-minutes			15-minutes		
Period	Period from	Period to	Period	Period from	Period to
03:00 – 04:00	3	4	03:00 – 03:15	12	13
			03:15 – 03:30	13	14
			03:30 – 03:45	14	15
			03:45 – 04:00	15	16
04:00 – 05:00	4	5	04:00 – 04:15	16	17
			04:15 – 04:30	17	18
			04:30 – 04:45	18	19
			04:45 – 05:00	19	20
05:00 – 06:00	5	6	05:00 – 05:15	20	21
			05:15 – 05:30	21	22
			05:30 – 05:45	22	23
			05:45 – 06:00	23	24
06:00 – 07:00	6	7	06:00 – 06:15	24	25
			06:15 – 06:30	25	26
			06:30 – 06:45	26	27
			06:45 – 07:00	27	28
07:00 – 08:00	7	8	07:00 – 07:15	28	29
			07:15 – 07:30	29	30
			07:30 – 07:45	30	31
			07:45 – 08:00	31	32
08:00 – 09:00	8	9	08:00 – 08:15	32	33
			08:15 – 08:30	33	34
			08:30 – 08:45	34	35
			08:45 – 09:00	35	36
09:00 – 10:00	9	10	09:00 – 09:15	36	37
			09:15 – 09:30	37	38
			09:30 – 09:45	38	39
			09:45 – 10:00	39	40
10:00 – 11:00	10	11	10:00 – 10:15	40	41
			10:15 – 10:30	41	42

Length of product period					
60-minutes			15-minutes		
Period	Period from	Period to	Period	Period from	Period to
			10:30 – 10:45	42	43
			10:45 – 11:00	43	44
11:00 – 12:00	11	12	11:00 – 11:15	44	45
			11:15 – 11:30	45	46
			11:30 – 11:45	46	47
			11:45 – 12:00	47	48
12:00 – 13:00	12	13	12:00 – 12:15	48	49
			12:15 – 12:30	49	50
			12:30 – 12:45	50	51
			12:45 – 13:00	51	52
13:00 – 14:00	13	14	13:00 – 13:15	52	53
			13:15 – 13:30	53	54
			13:30 – 13:45	54	55
			13:45 – 14:00	55	56
14:00 – 15:00	14	15	14:00 – 14:15	56	57
			14:15 – 14:30	57	58
			14:30 – 14:45	58	59
			14:45 – 15:00	59	60
15:00 – 16:00	15	16	15:00 – 15:15	60	61
			15:15 – 15:30	61	62
			15:30 – 15:45	62	63
			15:45 – 16:00	63	64
16:00 – 17:00	16	17	16:00 – 16:15	64	65
			16:15 – 16:30	65	66
			16:30 – 16:45	66	67
			16:45 – 17:00	67	68
17:00 – 18:00	17	18	17:00 – 17:15	68	69
			17:15 – 17:30	69	70
			17:30 – 17:45	70	71
			17:45 – 18:00	71	72

Length of product period					
60-minutes			15-minutes		
Period	Period from	Period to	Period	Period from	Period to
18:00 – 19:00	18	19	18:00 – 18:15	72	73
			18:15 – 18:30	73	74
			18:30 – 18:45	74	75
			18:45 – 19:00	75	76
19:00 – 20:00	19	20	19:00 – 19:15	76	77
			19:15 – 19:30	77	78
			19:30 – 19:45	78	79
			19:45 – 20:00	79	80
20:00 – 21:00	20	21	20:00 – 20:15	80	81
			20:15 – 20:30	81	82
			20:30 – 20:45	82	83
			20:45 – 21:00	83	84
21:00 – 22:00	21	22	21:00 – 21:15	84	85
			21:15 – 21:30	85	86
			21:30 – 21:45	86	87
			21:45 – 22:00	87	88
22:00 – 23:00	22	23	22:00 – 22:15	88	89
			22:15 – 22:30	89	90
			22:30 – 22:45	90	91
			22:45 – 23:00	91	92
23:00 – 24:00	23	24	23:00 – 23:15	92	93
			23:15 – 23:30	93	94
			23:30 – 23:45	94	95
			23:45 – 24:00	95	96

Table 82 **Table 83** Converter for usage of periods within intraday market

4.3.2 Reception of orders (E-06_01)

Reception of orders is carried out by request for order submission in *ISOTEDATA-VDT.801* structure (message-code=801) and by response in *RESPONSE-VDT.802* structure (indication of success/failure) and *ISOTEDATA-VDT.803* structure (description of order registered in the system). Market participant is not informed about successfully submitted order, but is informed about successful reception of order on ISOT side due to manners of synchronous communication (see chapter 3.2).

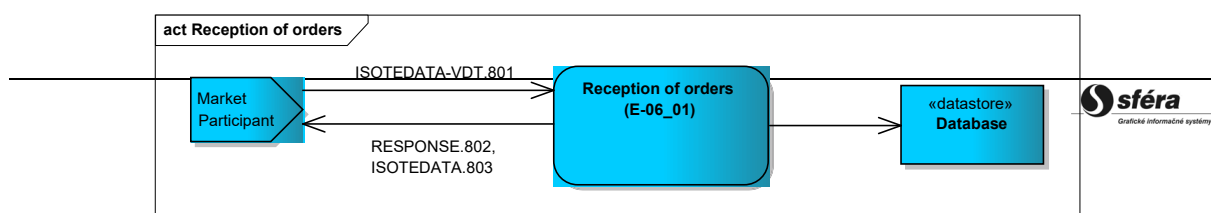

Figure 24 Schema of market participant order reception**ISOTEDATA-VDT.801**

The structure contains *message-code=801* attribute in the header and is filled out in accordance with [ISOTEDATA-VDT](#). Only a single order can be concurrently entered, i.e. submission of multiple orders is carried out through multiple calls.

```
<ISOTEDATA id="1" message-code="801" date-time="2016-06-20T00:00:00" dtd-version="1" dtd-release="1" answer-required="false"
xmlns="http://sfera.sk/xmtrade/isot/types/IDM/2016/04/01">
  <SenderIdentification id="24X--YOUR-EIC--B " coding-scheme="15" />
  <ReceiverIdentification id="24X-OT-SK-----V" coding-scheme="15" />
  <Trade trade-day="2016-02-16" order-expiration="2016-02-15T19:30:10" trade-type="N" block-order="N" indication="N" trade-stage="P" delivery-duration="60" market-area="SK" sett-curr="EUR" market="VDT" >
    <ProfileData profile-role="BC01">
      <Data period-from="0" period-to="1" value="19.1" unit="MW" />
    </ProfileData>
    <ProfileData profile-role="BP01">
      <Data period-from="0" period-to="1" value="75.00" unit="EUR" />
    </ProfileData>
    <Party id="24X--YOUR-EIC--B " role="TO" />
  </Trade>
</ISOTEDATA>
```

Example 14 Submission of 60-minutes sale order**RESPONSE-VDT.802**

In accordance with specification of [RESPONSE-VDT](#) structure, response is given in case of successful or unsuccessful order processing. In this case *message-code=802* can be found in the header.

```
<RESPONSE id="cb4d980f-2f9a-4be7-96ef-850be04b214" message-code="812"
date-time="2009-07-03T13:46:26Z" dtd-version="1" dtd-release="1"
xmlns="http://sfera.sk/ws/xmtrade/isot/interfaces/ut/types/2009/04/01">
  <SenderIdentification id="24X-OT-SK-----V" coding-scheme="15" />
  <ReceiverIdentification id="24X-ENTRADE-SK-9" coding-scheme="15" />
  <Reference id="1"/>
  <Reason code="0" type="A03" trade-id="1016"/>
</RESPONSE>
```

Example 15 Response on success of order submission**ISOTEDATA-VDT.803**

The structure is returned in the form it was registered in the system in case of successful order processing. In this case *message-code=803* can be found in the header.

```

<ISOTEDATA id="ac5e799q-2qtr-75e7-9bef-8aabc02b7f4" message-code="803"
  date-time="2016-02-15T16:30:10Z" dtd-version="1" dtd-release="1" answer-
  required="false"
  xmlns="http://sfera.sk/xmtrade/isot/types/IDM/2016/04/01">
  <SenderIdentification id="24X--YOUR-EIC--B " coding-scheme="15"/>
  <ReceiverIdentification id="24X-OT-SK-----V" coding-scheme="15" />
  <Reference id="1"/>
  <Trade trade-day="2016-02-16" order-expiration="2016-02-15T19:30:10" trade-type="N" block-
  order="N" indication="N" trade-stage="P" delivery-duration="60" market-area="SK" sett-
  curr="EUR" market="VDT">
    <TimeData datetime="2016-02-15T16:30:10Z" datetime-type="DTC"/>
    <ProfileData profile-role="BC01">
      <Data period-from="0" period-to="1" value="19.1" unit="MW" />
    </ProfileData>
    <ProfileData profile-role="BP01">
      <Data period-from="0" period-to="1" value="75.00" unit="EUR" />
    </ProfileData>
    <Party id="24X--YOUR-EIC--B " role="TO"/>
  </Trade>
</ISOTEDATA>

```

Example 16 Response with description of entered order in the system

4.3.3 Modification of orders (E-06_02)

Modification of orders is realized by request for modification of order in structure ISOTEDATA-VDT.804 and by response in structure RESPONSE-VDT.805 (indication of success/failure). Market participant is not informed about successfully modified order, but is informed about successful reception of instruction for order modification on ISOT side due to manners of synchronous communication (see chapter 3.2).

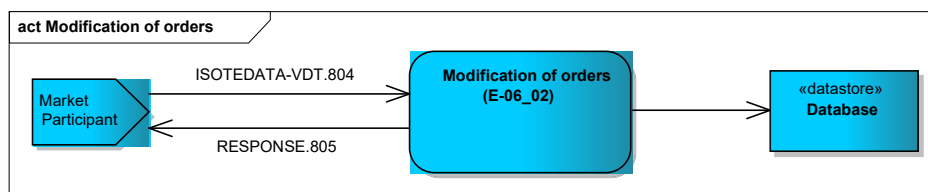

Figure 25 Reception of order scheme

Market participant can modify status of the order in case of request for modification. Activating, deactivating or canceling already inputted order can be done through external interfaces.

ISOTEDATA-VDT.804

The structure contains *message-code=804* attribute in the header and is filled out in accordance with [ISOTEDATA-VDT](#). Only a single order can be concurrently entered, i.e. submission of multiple orders is carried out through multiple calls.

```

<ISOTEDATA id="Your_own_ID_for_this_message" message-code="802" date-time="2011-01-
18T09:52:37" dtd-version="1" dtd-release="1" answer-required="false"
xmlns="http://sfera.sk/xmtrade/isot/types/IDM/2016/04">
  <SenderIdentification id="24X--YOUR-EIC--B" coding-scheme="15" />
  <ReceiverIdentification id="24X-OT-SK-----V" coding-scheme="15" />
  <Trade id="1234" trade-stage="N" delivery-duration="60" market-area="SK" market="VDT">
    <Party id="24X--YOUR-EIC--B" role="TO" />
  </Trade>
</ISOTEDATA>

```

Example 17 Deactivation of order

RESPONSE-VDT.805

In accordance with specification of [RESPONSE-VDT](#) structure response is given in case of successful or unsuccessful order processing. In this case message-code=805 can be found in the header.

```
<RESPONSE id="cb4d980f-2f9a-4be7-96ef-850be04b214" message-code="805"
  date-time="2016-02-15T16:30:10Z" dtd-version="1" dtd-release="1"
  xmlns="http://sfera.sk/ws/xmtrade/isot/interfaces/ut/types/2009/04/01">
  <SenderIdentification id="24X-OT-SK-----V" coding-scheme="15" />
  <ReceiverIdentification id="24X--YOUR-EIC--B " coding-scheme="15" />
  <Reference id="1"/>
  <Reason code="0" type="A03"/>
</RESPONSE>
```

Example 18 Successful modification of order response

4.3.4 Provision of orders (E-06_03)

Provision of orders is carried out by request for provision of order in *CDSREQ-VDT.807* structure and response in *RESPONSE-VDT.809* structure (indication of success/fail) and *ISOTEDATA-VDT.809* structure (description of modified order).

Market participant can ask for provision of a specific order or every order for specific time frame in a request for modification of an order.

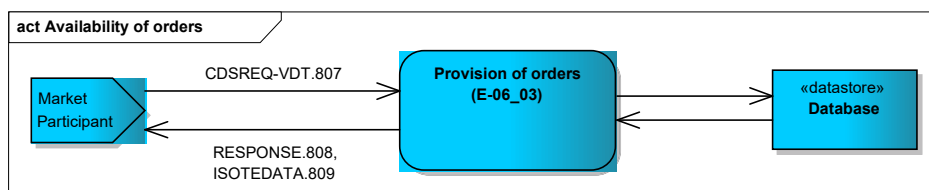

Figure 26 Provision of orders scheme

CDSREQ-VDT.807

The structure contains *message-code=807* attribute in the header and is filled out in accordance with structure specification of order provision. Request for order's data can be formulated either for specific order with order's identification in attribute *Trade/@id*, or via request for every order in given time period with attribute *Trade/@trade-day*. It is possible to specify time period with *Trade/@period-from* and *Trade/@period-to*.

```
<CDSREQ date-time="2017-04-11T07:00:00" dtd-release="1" dtd-version="1" id="45t" message-code="807"
  xmlns="http://sfera.sk/ws/xmtrade/isot/interfaces/ut/types/2009/04/01">
  <SenderIdentification coding-scheme="15" id="24X--YOUR-EIC--B"/>
  <ReceiverIdentification coding-scheme="15" id="24X-OT-SK-----V"/>
  <Trade id=1/>
</CDSREQ>
```

Example 19 Provision of specific order

```
<CDSREQ date-time="2017-04-11T07:00:00" dtd-release="1" dtd-version="1" id="45t" message-code="807"
  xmlns:ns=" http://sfera.sk/ws/xmtrade/isot/interfaces/ut/types/2009/04/01">
  <SenderIdentification coding-scheme="15" id="24X--YOUR-EIC--B"/>
  <ReceiverIdentification coding-scheme="15" id="24X-OT-SK-----V"/>
  <Trade trade-day="2017-02-12" period-from="8" period-to="16" delivery-duration = "60"/>
</CDSREQ>
```

Example 20 Provision of all orders in given time period

RESPONSE-VDT.808

In accordance with specification of [RESPONSE-VDT](#) structure response is given in case of successful or unsuccessful order processing. In this case message-code=808 can be found in the header.

```
<RESPONSE id="cb4d980f-2f9a-4be7-96ef-850be04b214" message-code="808"
  date-time="2016-02-15T16:30:10Z" dtd-version="1" dtd-release="1"
  xmlns="http://sfera.sk/ws/xmtrade/isot/interfaces/ut/types/2009/04/01">
  <SenderIdentification id="24X-OT-SK-----V" coding-scheme="15" />
  <ReceiverIdentification id="24X--YOUR-EIC--B " coding-scheme="15" />
  <Reference id="1"/>
  <Reason code="0" type="A03"/>
</RESPONSE>
```

Example 21 Successful modification of order response

ISOTEDATA-VDT.809

In case of successful order processing, the structure is returned as it was registered in the system with a message-code=809 in the header. Attribute Trade/@trade-stage contains status in which the order currently is. Interval of delivery is specified in attributes Trade/ProfileData/Data/@period-from and Trade/ProfileData/Data/@period-to. These intervals represent time periods order of a given day.

```
<ISOTEDATA id="ac5e799q-2qtr-75e7-9bef-8aabc02b7f4" message-code="809" date-time="2016-02-15T16:30:10Z" dtd-version="1" dtd-release="1" answer-required="false"
  xmlns="http://sfera.sk/xmtrade/isot/types/IDM/2016/04">
  <SenderIdentification id="24X-OT-SK-----V" coding-scheme="15"/>
  <ReceiverIdentification id="24X--YOUR-EIC--B " coding-scheme="15"/>
  <Reference id="1"/>
  <Trade id="1" trade-day="2016-02-16" order-expiration="2016-02-15T19:30:10" trade-type="N" block-order="N" indication="N" trade-stage="P" trader-id="123456" delivery-duration = "60" market-area="SK" sett-curr="EUR" market="VDT">
    <TimeData datetime="2016-02-15T16:30:10Z" datetime-type="DTC"/>
    <ProfileData profile-role="BC01">
      <Data period-from="10" period-to="11" value="19.1" unit="MW" />
    </ProfileData>
    <ProfileData profile-role="BP01">
      <Data period-from="10" period-to="11" value="75.00" unit="EUR" />
    </ProfileData>
    <Party id="24X--YOUR-EIC--B " role="TO"/>
  </Trade>
  <Trade id="2" trade-day="2016-02-16" order-expiration="2016-02-15T19:30:10" trade-type="N" block-order="N" indication="N" trade-stage="P" trader-id="123456" delivery-duration = "60" market-area="SK" sett-curr="EUR" market="VDT">
    <TimeData datetime="2016-02-15T16:35:10Z" datetime-type="DTC"/>
    <ProfileData profile-role="BC01">
      <Data period-from="10" period-to="11" value="2" unit="MW" />
    </ProfileData>
    <ProfileData profile-role="BP01">
      <Data period-from="10" period-to="11" value="60.00" unit="EUR" />
    </ProfileData>
    <Party id="24X--YOUR-EIC--B " role="TO"/>
  </Trade>
</ISOTEDATA>
```

Example 22 Response with description of two available orders

4.4 Administration of intraday order book

Administration of intraday order book is carried out through operation intraday order book provision via IdmOrderBook web service. Within the coordinated cross-border intraday market, the IdmOrderBook web service will also allow market participants to obtain available cross-border capacities in the form of Hub-to-Hub matrix data.

4.4.1 Processing level

Market participants have the option to request data about the current order book status. Communication runs via AMQP protocol which automatically informs market participants about changes in the order book. For more information about automated notifications which inform about changes in intraday order book, see Chapters 3.2 and 4.7.

Depending on date of transition from domestic intraday market to coordinated cross-border intraday market under the SIDC (Single Intraday Coupling) project, the structure of order book data will also be extended by the information of period length. Information regarding the order book data will be additionally specified by period length (60 or 15 minutes) relating to the specific order type.

Using web service IdmOrderBook and Download method market participant gets information about all available quantities of offered/demanded limited prices per each period of relevant product in case of simple orders, or for all products, alternatively intervals in case of block orders. Using the download method, the market participant has further possibility to obtain overall traded quantity, last traded price and quantity including the price direction within the relevant period.

Moreover, market participants are able using the web service IdmOrderBook and method DownloadH2HMatrix to download information regarding available transmission cross-border capacities between SK trading area and other trading areas participating within the SIDC market. These data regarding cross-border capacities are of an exclusively informative nature and their availability may be subject to a delay compared to the real state in the central intraday market order matching solution within the SIDC.

4.4.2 The order book data (E-08_01)

Provision of order book data is realized by request for provision of order book in CDSREQ-VDT.810 structure and response in RESPONSE-VDT.811 structure (success/failure) and ISOTEDATA-VDT.81 (description of the order book data).

In response, market participant gets all available amounts for a specific time frame in the order book.

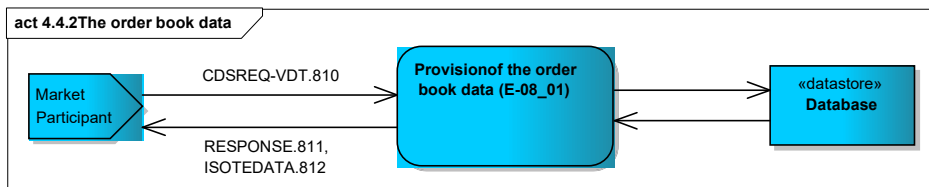

Figure 27 Provision of order book data scheme

CDSREQ-VDT.810

The structure contains message-code=810 attribute in the header and is filled out in accordance with specification of order book provision structure. Request for the order book data is realized with optional possibility to specify period length (60 or 15 minutes) within the Trade/@delivery-duration element. System automatically evaluate current status of the order book after reception of a request and provides status for specified time period. In the case of not defining the information on the length of the period, all data will be made available broken down by the length of the trading period. Market participant receive data for specific time period in response.

```

<CDSREQ date-time="2017-04-11T07:00:00" dtd-release="1" dtd-version="1" id="45t" message-code="810"
xmlns="http://sfera.sk/ws/xmtrade/isot/interfaces/ut/types/2009/04/01">
  <SenderIdentification coding-scheme="15" id="24X--YOUR-EIC--B"/>
  <ReceiverIdentification coding-scheme="15" id="24X-OT-SK-----V"/>
</CDSREQ>
  
```

Example 23 Provision of order book

```
<CDSREQ date-time="2017-04-11T07:00:00" dtd-release="1" dtd-version="1" id="45t" message-
code="810"
xmlns="http://sfera.sk/ws/xmtrade/isot/interfaces/ut/types/2009/04/01">
  <SenderIdentification coding-scheme="15" id="24X--YOUR-EIC--B"/>
  <ReceiverIdentification coding-scheme="15" id="24X-OT-SK-----V"/>
  <Trade delivery-duration="60"/>
</CDSREQ>
```

Example 24 Provision of order book for specific period length

RESPONSE-VDT.811

In accordance with specification of RESPONSE structure, response is given in case of successful or unsuccessful order processing. In this case message-code=811 can be found in the header.

```
<RESPONSE id="cb4d980f-2f9a-4be7-96ef-850be04b214" message-code="811"
date-time="2016-02-15T16:30:10Z" dtd-version="1" dtd-release="1"
xmlns="http://sfera.sk/ws/xmtrade/isot/interfaces/ut/types/2009/04/01">
  <SenderIdentification id="24X-OT-SK-----V" coding-scheme="15" />
  <ReceiverIdentification id="24X--YOUR-EIC--B " coding-scheme="15" />
  <Reference id="1"/>
  <Reason code="0" type="A03"/>
</RESPONSE>
```

Example 25 Response about successful processing of order book data provision request

ISOTEDATA-VDT.812

In case of successful order processing, all available order book data are returned for a given time period and period length and message-code=812 can be found in the header. Information about amount of particular types of orders are ordered in limited prices and periods can be found in response. Attribute Trade/ProfileData/Data/@seq-num order different prices of periods according to view of the market participant from the best price (the highest for purchase, the lowest for sale) to the worst price (the lowest for purchase, the lowest for sale). Matching of user-defined block orders is established on different principals as other type of orders, so it is not possible aggregate amount of orders after inputted prices. For this reason, availability of marked user-defined block orders is shown under anonymous ID in attribute Trade/ProfileData/@trade-id. Further it is possible to obtain statistics of the orderbook in extent of overall traded quantity (MW) within the relevant period using the attribute Trade/ProfileData/@profile-role="TC01", last traded quantity (MW) within the period using the attribute Trade/ProfileData/@profile-role="LC01" and last price (EUR/MWh) including the price direction using the attribute Trade/ProfileData/@profile-role="LP01".

```
<?xml version="1.0" encoding="utf-8"?>
<ISOTEDATA id="ac5e799q-2qtr-75e7-9bef-8aabc02b7f4" message-code="812"
date-time="2016-02-15T16:30:10Z" dtd-version="1" dtd-release="1" answer-required="false"
xmlns="http://sfera.sk/xmtrade/isot/types/IDM/2016/04">
  <SenderIdentification id="24X-OT-SK-----V" coding-scheme="15"/>
  <ReceiverIdentification id="24X--YOUR-EIC--B" coding-scheme="15" />
  <Reference id="1"/>
  <!--den D, posledná cena/množstvo-->
  <Trade trade-day="2016-07-13" delivery-duration="60" market-area="SK" sett-curr="EUR" market="VDT">
    <TimeData datetime="2016-07-13T09:30:10.123Z" datetime-type="DTO"/>
    <ProfileData profile-role="TC01">
      <Data period-from="10" period-to="11" value="105" unit="MW"/>
      <Data period-from="11" period-to="12" value="246" unit="MW"/>
      <Data period-from="12" period-to="13" value="231.3" unit="MW"/>
      <Data period-from="13" period-to="14" value="101.5" unit="MW"/>
      <Data period-from="14" period-to="15" value="594.3" unit="MW"/>
      <Data period-from="15" period-to="16" value="3232.1" unit="MW"/>
      <Data period-from="16" period-to="17" value="1123.4" unit="MW"/>
      <Data period-from="17" period-to="18" value="340.1" unit="MW"/>
      <Data period-from="18" period-to="19" value="764.5" unit="MW"/>
      <Data period-from="19" period-to="20" value="100.5" unit="MW"/>
      <Data period-from="20" period-to="21" value="126.3" unit="MW"/>
      <Data period-from="21" period-to="22" value="314.2" unit="MW"/>
      <Data period-from="22" period-to="23" value="500" unit="MW"/>
      <Data period-from="23" period-to="24" value="5000" unit="MW"/>
    </ProfileData>
    <ProfileData profile-role="LC01">
      <Data period-from="10" period-to="11" value="5" unit="MW"/>
      <Data period-from="11" period-to="12" value="6" unit="MW"/>
      <Data period-from="12" period-to="13" value="2.1" unit="MW"/>
      <Data period-from="13" period-to="14" value="10" unit="MW"/>
      <Data period-from="14" period-to="15" value="5" unit="MW"/>
      <Data period-from="15" period-to="16" value="3" unit="MW"/>
      <Data period-from="16" period-to="17" value="1" unit="MW"/>
      <Data period-from="17" period-to="18" value="0.1" unit="MW"/>
      <Data period-from="18" period-to="19" value="0.5" unit="MW"/>
      <Data period-from="19" period-to="20" value="10.5" unit="MW"/>
      <Data period-from="20" period-to="21" value="12" unit="MW"/>
      <Data period-from="21" period-to="22" value="11" unit="MW"/>
      <Data period-from="22" period-to="23" value="50" unit="MW"/>
      <Data period-from="23" period-to="24" value="500" unit="MW"/>
    </ProfileData>
    <ProfileData profile-role="LP01">
      <Data period-from="10" period-to="11" value="110" unit="EUR" price-direction="N"/>
      <Data period-from="11" period-to="12" value="121.22" unit="EUR" price-direction="I"/>
      <Data period-from="12" period-to="13" value="114" unit="EUR" price-direction="D"/>
      <Data period-from="13" period-to="14" value="55" unit="EUR" price-direction="D"/>
      <Data period-from="14" period-to="15" value="59.3" unit="EUR" price-direction="I"/>
      <Data period-from="15" period-to="16" value="142" unit="EUR" price-direction="I"/>
      <Data period-from="16" period-to="17" value="150" unit="EUR" price-direction="N"/>
      <Data period-from="17" period-to="18" value="5" unit="EUR" price-direction="D"/>
      <Data period-from="18" period-to="19" value="0.12" unit="EUR" price-direction="D"/>
      <Data period-from="19" period-to="20" value="123" unit="EUR" price-direction="I"/>
      <Data period-from="20" period-to="21" value="45" unit="EUR" price-direction="D"/>
      <Data period-from="21" period-to="22" value="89" unit="EUR" price-direction="D"/>
      <Data period-from="22" period-to="23" value="90.2" unit="EUR" price-direction="I"/>
      <Data period-from="23" period-to="24" value="15" unit="EUR" price-direction="D"/>
    </ProfileData>
  </Trade>
  <!--den D+1, posledná cena/množstvo-->
  <Trade trade-day="2016-07-14" delivery-duration="60" market-area="SK" sett-curr="EUR" market="VDT">
    <TimeData datetime="2016-07-13T09:30:10.123Z" datetime-type="DTO"/>
    <ProfileData profile-role="TC01">
      <Data period-from="0" period-to="1" value="105" unit="MW"/>
      <Data period-from="1" period-to="2" value="246" unit="MW"/>
      <Data period-from="2" period-to="3" value="231.3" unit="MW"/>
      <Data period-from="3" period-to="4" value="101.5" unit="MW"/>
      <Data period-from="4" period-to="5" value="594.3" unit="MW"/>
      <Data period-from="5" period-to="6" value="3232.1" unit="MW"/>
      <Data period-from="6" period-to="7" value="1123.4" unit="MW"/>
      <Data period-from="7" period-to="8" value="340.1" unit="MW"/>
      <Data period-from="8" period-to="9" value="764.5" unit="MW"/>
      <Data period-from="9" period-to="10" value="100.5" unit="MW"/>
      <Data period-from="10" period-to="11" value="126.3" unit="MW"/>
      <Data period-from="11" period-to="12" value="246" unit="MW"/>
      <Data period-from="12" period-to="13" value="231.3" unit="MW"/>
      <Data period-from="13" period-to="14" value="101.5" unit="MW"/>
      <Data period-from="14" period-to="15" value="594.3" unit="MW"/>
      <Data period-from="15" period-to="16" value="3232.1" unit="MW"/>
      <Data period-from="16" period-to="17" value="1123.4" unit="MW"/>
      <Data period-from="17" period-to="18" value="340.1" unit="MW"/>
      <Data period-from="18" period-to="19" value="764.5" unit="MW"/>
      <Data period-from="19" period-to="20" value="100.5" unit="MW"/>
      <Data period-from="20" period-to="21" value="126.3" unit="MW"/>
      <Data period-from="21" period-to="22" value="314.2" unit="MW"/>
      <Data period-from="22" period-to="23" value="500" unit="MW"/>
      <Data period-from="23" period-to="24" value="5000" unit="MW"/>
    </ProfileData>
  </Trade>
</ISOTEDATA>
```

```
<ProfileData profile-role="LC01">
  <Data period-from="0" period-to="1" value="5" unit="MW"/>
  <Data period-from="1" period-to="2" value="6" unit="MW"/>
  <Data period-from="2" period-to="3" value="2.1" unit="MW"/>
  <Data period-from="3" period-to="4" value="10" unit="MW"/>
  <Data period-from="4" period-to="5" value="5" unit="MW"/>
  <Data period-from="5" period-to="6" value="3" unit="MW"/>
  <Data period-from="6" period-to="7" value="1" unit="MW"/>
  <Data period-from="7" period-to="8" value="0.1" unit="MW"/>
  <Data period-from="8" period-to="9" value="0.5" unit="MW"/>
  <Data period-from="9" period-to="10" value="10.5" unit="MW"/>
  <Data period-from="10" period-to="11" value="5" unit="MW"/>
  <Data period-from="11" period-to="12" value="6" unit="MW"/>
  <Data period-from="12" period-to="13" value="2.1" unit="MW"/>
  <Data period-from="13" period-to="14" value="10" unit="MW"/>
  <Data period-from="14" period-to="15" value="5" unit="MW"/>
  <Data period-from="15" period-to="16" value="3" unit="MW"/>
  <Data period-from="16" period-to="17" value="1" unit="MW"/>
  <Data period-from="17" period-to="18" value="0.1" unit="MW"/>
  <Data period-from="18" period-to="19" value="0.5" unit="MW"/>
  <Data period-from="19" period-to="20" value="10.5" unit="MW"/>
  <Data period-from="20" period-to="21" value="12" unit="MW"/>
  <Data period-from="21" period-to="22" value="11" unit="MW"/>
  <Data period-from="22" period-to="23" value="50" unit="MW"/>
  <Data period-from="23" period-to="24" value="500" unit="MW"/>
</ProfileData>
<ProfileData profile-role="LP01">
  <Data period-from="0" period-to="1" value="110" unit="EUR" price-direction="N"/>
  <Data period-from="1" period-to="2" value="121.22" unit="EUR" price-direction="I"/>
  <Data period-from="2" period-to="3" value="114" unit="EUR" price-direction="D"/>
  <Data period-from="3" period-to="4" value="55" unit="EUR" price-direction="D"/>
  <Data period-from="4" period-to="5" value="59.3" unit="EUR" price-direction="I"/>
  <Data period-from="5" period-to="6" value="142" unit="EUR" price-direction="I"/>
  <Data period-from="6" period-to="7" value="150" unit="EUR" price-direction="N"/>
  <Data period-from="7" period-to="8" value="-5" unit="EUR" price-direction="D"/>
  <Data period-from="8" period-to="9" value="0.12" unit="EUR" price-direction="D"/>
  <Data period-from="9" period-to="10" value="123" unit="EUR" price-direction="I"/>
  <Data period-from="10" period-to="11" value="110" unit="EUR" price-direction="N"/>
  <Data period-from="11" period-to="12" value="121.22" unit="EUR" price-direction="I"/>
  <Data period-from="12" period-to="13" value="114" unit="EUR" price-direction="D"/>
  <Data period-from="13" period-to="14" value="55" unit="EUR" price-direction="D"/>
  <Data period-from="14" period-to="15" value="59.3" unit="EUR" price-direction="I"/>
  <Data period-from="15" period-to="16" value="142" unit="EUR" price-direction="I"/>
  <Data period-from="16" period-to="17" value="150" unit="EUR" price-direction="N"/>
  <Data period-from="17" period-to="18" value="-5" unit="EUR" price-direction="D"/>
  <Data period-from="18" period-to="19" value="0.12" unit="EUR" price-direction="D"/>
  <Data period-from="19" period-to="20" value="123" unit="EUR" price-direction="I"/>
  <Data period-from="20" period-to="21" value="45" unit="EUR" price-direction="D"/>
  <Data period-from="21" period-to="22" value="89" unit="EUR" price-direction="D"/>
  <Data period-from="22" period-to="23" value="90.2" unit="EUR" price-direction="I"/>
  <Data period-from="23" period-to="24" value="15" unit="EUR" price-direction="D"/>
</ProfileData>
</Trade>
<!-Jednoduché objednávky, nákup, den D-->
<Trade trade-day="2016-07-13" trade-type="N" block-order="N" delivery-duration="60" market-area="SK" sett-curr="EUR" market="VDT">
  <!--datum a čas okamihu casoveho rezu orderbooku-->
  <TimeData datetime="2016-07-13T09:30:10.123Z" datetime-type="DTO"/>
  <ProfileData profile-role="BC01">
    <Data period-from="12" period-to="13" value="5" unit="MW" seq-num="1"/>
  </ProfileData>
  <ProfileData profile-role="BP01">
    <Data period-from="12" period-to="13" value="31" unit="EUR" seq-num="1"/>
  </ProfileData>
  <ProfileData profile-role="BC01">
    <Data period-from="12" period-to="13" value="5" unit="MW" seq-num="2"/>
  </ProfileData>
  <ProfileData profile-role="BP01">
    <Data period-from="12" period-to="13" value="25" unit="EUR" seq-num="2"/>
  </ProfileData>
  <ProfileData profile-role="BC01">
    <Data period-from="15" period-to="16" value="3" unit="MW" seq-num="1"/>
  </ProfileData>
  <ProfileData profile-role="BP01">
    <Data period-from="15" period-to="16" value="35" unit="EUR" seq-num="1"/>
  </ProfileData>
  <ProfileData profile-role="BC01">
    <Data period-from="16" period-to="17" value="10" unit="MW" seq-num="1"/>
  </ProfileData>
  <ProfileData profile-role="BP01">
    <Data period-from="16" period-to="17" value="30" unit="EUR" seq-num="1"/>
  </ProfileData>
  <ProfileData profile-role="BC01">
    <Data period-from="16" period-to="17" value="10" unit="MW" seq-num="2"/>
  </ProfileData>
  <ProfileData profile-role="BP01">
    <Data period-from="16" period-to="17" value="20" unit="EUR" seq-num="2"/>
  </ProfileData>
</Trade>
```

```
<ProfileData profile-role="BC01">
  <Data period-from="16" period-to="17" value="5" unit="MW" seq-num="3"/>
</ProfileData>
<ProfileData profile-role="BP01">
  <Data period-from="16" period-to="17" value="18.73" unit="EUR" seq-num="3"/>
</ProfileData>
</Trade>
<!--Jednoduché objednávky, predaj, den D-->
<Trade trade-day="2016-07-13" trade-type="P" block-order="N" delivery-duration="60" market-area="SK" sett-curr="EUR" market="VDT">
  <TimeData datetime="2016-07-13T09:30:10.123Z" datetime-type="DTO"/>
  <ProfileData profile-role="BC01">
    <Data period-from="12" period-to="13" value="10" unit="MW" seq-num="1"/>
  </ProfileData>
  <ProfileData profile-role="BP01">
    <Data period-from="12" period-to="13" value="33" unit="EUR" seq-num="1"/>
  </ProfileData>
  <ProfileData profile-role="BC01">
    <Data period-from="12" period-to="13" value="10" unit="MW" seq-num="2"/>
  </ProfileData>
  <ProfileData profile-role="BP01">
    <Data period-from="12" period-to="13" value="40" unit="EUR" seq-num="2"/>
  </ProfileData>
  <ProfileData profile-role="BC01">
    <Data period-from="12" period-to="13" value="5" unit="MW" seq-num="3"/>
  </ProfileData>
  <ProfileData profile-role="BP01">
    <Data period-from="12" period-to="13" value="41" unit="EUR" seq-num="3"/>
  </ProfileData>
  <ProfileData profile-role="BC01">
    <Data period-from="14" period-to="15" value="1" unit="MW" seq-num="1"/>
  </ProfileData>
  <ProfileData profile-role="BP01">
    <Data period-from="14" period-to="15" value="20" unit="EUR" seq-num="1"/>
  </ProfileData>
  <ProfileData profile-role="BC01">
    <Data period-from="16" period-to="17" value="10" unit="MW" seq-num="1"/>
  </ProfileData>
  <ProfileData profile-role="BP01">
    <Data period-from="16" period-to="17" value="45" unit="EUR" seq-num="1"/>
  </ProfileData>
  <ProfileData profile-role="BC01">
    <Data period-from="16" period-to="17" value="10" unit="MW" seq-num="2"/>
  </ProfileData>
  <ProfileData profile-role="BP01">
    <Data period-from="16" period-to="17" value="46" unit="EUR" seq-num="2"/>
  </ProfileData>
  <ProfileData profile-role="BC01">
    <Data period-from="16" period-to="17" value="2" unit="MW" seq-num="3"/>
  </ProfileData>
  <ProfileData profile-role="BP01">
    <Data period-from="16" period-to="17" value="46.15" unit="EUR" seq-num="3"/>
  </ProfileData>
</Trade>
<!--Jednoduché objednávky, nákup, den D+1-->
<Trade trade-day="2016-07-14" trade-type="N" block-order="N" delivery-duration="60" market-area="SK" sett-curr="EUR" market="VDT">
  <TimeData datetime="2016-07-13T09:30:10.123Z" datetime-type="DTO"/>
  <ProfileData profile-role="BC01">
    <Data period-from="0" period-to="1" value="5" unit="MW" seq-num="1"/>
  </ProfileData>
  <ProfileData profile-role="BP01">
    <Data period-from="0" period-to="1" value="20" unit="EUR" seq-num="1"/>
  </ProfileData>
</Trade>
<!--Jednoduché objednávky, predaj, den D+1-->
<Trade trade-day="2016-07-14" trade-type="P" block-order="N" delivery-duration="60" market-area="SK" sett-curr="EUR" market="VDT">
  <TimeData datetime="2016-07-13T09:30:10.123Z" datetime-type="DTO"/>
  <ProfileData profile-role="BC01">
    <Data period-from="0" period-to="1" value="1" unit="MW" seq-num="1"/>
  </ProfileData>
  <ProfileData profile-role="BP01">
    <Data period-from="0" period-to="1" value="21" unit="EUR" seq-num="1"/>
  </ProfileData>
  <ProfileData profile-role="BC01">
    <Data period-from="0" period-to="1" value="1" unit="MW" seq-num="2"/>
  </ProfileData>
  <ProfileData profile-role="BP01">
    <Data period-from="0" period-to="1" value="23" unit="EUR" seq-num="2"/>
  </ProfileData>
</Trade>
```

```
<!--Blokove objednavky, nakup, Base load-->
<Trade trade-day="2016-07-14" trade-type="N" block-order="A" block-type="BL" delivery-duration="60" market-area="SK" sett-curr="EUR"
market="VDT">
  <TimeData datettime="2016-07-13T09:30:10.123Z" datettime-type="DTO"/>
  <ProfileData profile-role="BC01">
    <Data value="5" unit="MW" seq-num="1"/>
  </ProfileData>
  <ProfileData profile-role="BP01">
    <Data value="20" unit="EUR" seq-num="1"/>
  </ProfileData>
  <ProfileData profile-role="BC01">
    <Data value="1" unit="MW" seq-num="2"/>
  </ProfileData>
  <ProfileData profile-role="BP01">
    <Data value="18" unit="EUR" seq-num="2"/>
  </ProfileData>
</Trade>
<!--Blokove objednavky, predaj, Base load-->
<Trade trade-day="2016-07-14" trade-type="P" block-order="A" block-type="BL" delivery-duration="60" market-area="SK" sett-curr="EUR"
market="VDT">
  <TimeData datettime="2016-07-13T09:30:10.123Z" datettime-type="DTO"/>
  <ProfileData profile-role="BC01">
    <Data value="2" unit="MW" seq-num="1"/>
  </ProfileData>
  <ProfileData profile-role="BP01">
    <Data value="22" unit="EUR" seq-num="1"/>
  </ProfileData>
  <ProfileData profile-role="BC01">
    <Data value="1" unit="MW" seq-num="2"/>
  </ProfileData>
  <ProfileData profile-role="BP01">
    <Data value="23" unit="EUR" seq-num="2"/>
  </ProfileData>
</Trade>
<!--Blokove objednavky, nakup, Peak load-->
<Trade trade-day="2016-07-14" trade-type="N" block-order="A" block-type="PL" delivery-duration="60" market-area="SK" sett-curr="EUR"
market="VDT">
  <TimeData datettime="2016-07-13T09:30:10.123Z" datettime-type="DTO"/>
  <ProfileData profile-role="BC01">
    <Data value="4" unit="MW" seq-num="1"/>
  </ProfileData>
  <ProfileData profile-role="BP01">
    <Data value="17" unit="EUR" seq-num="1"/>
  </ProfileData>
  <ProfileData profile-role="BC01">
    <Data value="2" unit="MW" seq-num="2"/>
  </ProfileData>
  <ProfileData profile-role="BP01">
    <Data value="15" unit="EUR" seq-num="2"/>
  </ProfileData>
</Trade>
<!--Blokove objednavky, predaj, Peak load-->
<Trade trade-day="2016-07-14" trade-type="P" block-order="A" block-type="PL" delivery-duration="60" market-area="SK" sett-curr="EUR"
market="VDT">
  <TimeData datettime="2016-07-13T09:30:10.123Z" datettime-type="DTO"/>
  <ProfileData profile-role="BC01">
    <Data value="3" unit="MW" seq-num="1"/>
  </ProfileData>
  <ProfileData profile-role="BP01">
    <Data value="18" unit="EUR" seq-num="1"/>
  </ProfileData>
</Trade>
<!--Blokove objednavky, nakup, Off-peak-->
<Trade trade-day="2016-07-14" trade-type="N" block-order="A" block-type="OP" delivery-duration="60" market-area="SK" sett-curr="EUR"
market="VDT">
  <TimeData datettime="2016-07-13T09:30:10.123Z" datettime-type="DTO"/>
  <ProfileData profile-role="BC01">
    <Data value="1" unit="MW" seq-num="1"/>
  </ProfileData>
  <ProfileData profile-role="BP01">
    <Data value="12" unit="EUR" seq-num="1"/>
  </ProfileData>
</Trade>
```

```

<!--Blokove objednavky, predaj, Off-peak-->
<Trade trade-day="2016-07-14" trade-type="P" block-order="A" block-type="OP" delivery-duration="60" market-area="SK" sett-curr="EUR"
market="VDT">
  <TimeData datetime="2016-07-13T09:30:10.123Z" datetime-type="DTO"/>
  <ProfileData profile-role="BC01">
    <Data value="3" unit="MW" seq-num="1"/>
  </ProfileData>
  <ProfileData profile-role="BP01">
    <Data value="12.1" unit="EUR" seq-num="1"/>
  </ProfileData>
  <ProfileData profile-role="BC01">
    <Data value="3" unit="MW" seq-num="2"/>
  </ProfileData>
  <ProfileData profile-role="BP01">
    <Data value="12.5" unit="EUR" seq-num="2"/>
  </ProfileData>
</Trade>
<!--Blokove objednavky, nakup, vlastne-->
<Trade trade-day="2016-07-13" trade-type="N" block-order="A" block-type="V" delivery-duration="60" market-area="SK" sett-curr="EUR"
market="VDT">
  <TimeData datetime="2016-07-13T09:30:10.123Z" datetime-type="DTO"/>
  <ProfileData profile-role="BC01" trade-id="2920CAF91042B1841B32D9E3E63E7C75">
    <Data period-from="16" period-to="19" value="1" unit="MW"/>
  </ProfileData>
  <ProfileData profile-role="BP01" trade-id="2920CAF91042B1841B32D9E3E63E7C75">
    <Data period-from="16" period-to="19" value="12" unit="EUR"/>
  </ProfileData>
</Trade>
</ISOTEDATA>

```

Example 26 Response with description of order book snapshot

4.4.3 Available cross-border transmission capacities data H2H (E-08_02)

Provision of available cross-border transmission capacities in format of Hub-to-Hub (H2H) is ensured by requests in structure CDSREQ-VDT.840 and responses in structure RESPONSE-VDT.811 (indication of success/unsuccess) and ISOTEDATA-VDT.812 (description of cross-border capacities data).

Response containing cross-border capacities includes all available data related to available cross-border capacities for specified time period.

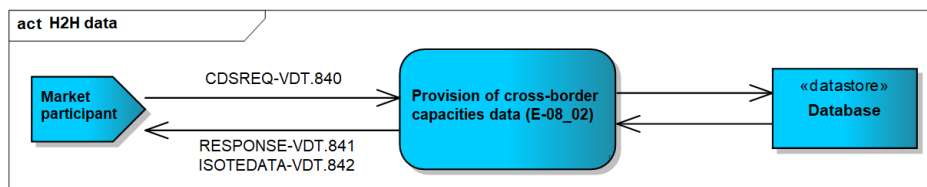

Figure 28 Provision of cross-border capacities scheme

CDSREQ-VDT.840

Structure contains attribute message-code=840 within the header and has to be filled up according to specification of structure for provision of cross-border capacities data. Request for cross-border capacities data may be realized with optional possibility to specify relevant trading period(s) and the system automatically evaluates the current state of cross-border capacities data and provides them for required filter of periods. In case of not defining the information on the length of the period, all data will be made available broken down by business period. The data on the time slice will be made available to the market participant in the response together with the data.

```

<CDSREQ date-time="2019-01-01T07:00:00" dtd-release="1" dtd-version="1" id="45t" message-
code="840" xmlns="http://sfera.sk/ws/xmtrade/isot/interfaces/ut/types/2009/04/01">
  <SenderIdentification coding-scheme="15" id="24X--YOUR-EIC--B"/>
  <ReceiverIdentification coding-scheme="15" id="24X-OT-SK-----V"/>
  <Trade trade-day="2022-09-27" period-from="12" period-to="13"/>
</CDSREQ>

```

Example 27 Provision of available cross-border capacities for IDM (H2H)

RESPONSE-VDT.841

In accordance with specification of RESPONSE structure, response is given in case of successful or unsuccessful order processing. In this case message-code=841 can be found in the header.

```
<RESPONSE id="2bb436c9a4c84d3eb7c2002b4c8602bc" message-code="841" date-time="2022-09-27T09:21:44Z" dtd-version="1" dtd-release="1"
xmlns="http://sfera.sk/ws/xmtrade/isot/interfaces/ut/types/2009/04/01">
  <SenderIdentification id="24X-OT-SK-----V" coding-scheme="15"/>
  <ReceiverIdentification id="24X--YOUR-EIC--B" coding-scheme="15"/>
  <Reference id="45t"/>
  <Reason code="0" type="A03"/>
</RESPONSE>
```

Example 28 Response about successful processing of IDM cross-border capacities data provision request

ISOTEDATA-VDT.842

In case of successful order processing, all available cross-border capacities data in the form of H2H matrix are returned for a given time period and message-code=842 can be found in the header. Response includes available capacities broken down by relevant direction and cross-border profiles including the information related to granularity of the value (15/60-min product).

```

<ISOTEDATA id="22158dc52e74481bbf15ea90fcc1c24c" message-code="842" date-time="2022-09-27T09:21:44Z" dtd-version="1" dtd-release="1"
answer-required="false" xmlns="http://sfera.sk/ws/xmtrade/isot/interfaces/ut/types/2009/04/01">
  <SenderIdentification id="24X-OT-SK-----V" coding-scheme="15" xmlns="http://sfera.sk/xmtrade/isot/types/IDM/2016/04"/>
  <ReceiverIdentification id="11XAENSK-----B" coding-scheme="15" xmlns="http://sfera.sk/xmtrade/isot/types/IDM/2016/04"/>
  <Reference id="45t" xmlns="http://sfera.sk/xmtrade/isot/types/IDM/2016/04"/>
  <Trade trade-day="2022-09-27" market="VDT" delivery-duration="60" market-area="SK" area-from="SK" area-to="AT"
xmlns="http://sfera.sk/xmtrade/isot/types/IDM/2016/04">
    <TimeData datetime="2022-09-27T11:21:44.6815426+02:00" datetime-type="DTO"/>
    <ProfileData profile-role="AC01">
      <Data period-from="0" period-to="1" value="0" unit="MW" seq-num="1"/>
    </ProfileData>
    <ProfileData profile-role="AC02">
      <Data period-from="0" period-to="1" value="0" unit="MW" seq-num="1"/>
    </ProfileData>
    <ProfileData profile-role="AC01">
      <Data period-from="1" period-to="2" value="0" unit="MW" seq-num="1"/>
    </ProfileData>
    <ProfileData profile-role="AC02">
      <Data period-from="1" period-to="2" value="0" unit="MW" seq-num="1"/>
    </ProfileData>
    <!--...missing periods ...-->
    <ProfileData profile-role="AC01">
      <Data period-from="21" period-to="22" value="1287" unit="MW" seq-num="1"/>
    </ProfileData>
    <ProfileData profile-role="AC02">
      <Data period-from="21" period-to="22" value="684" unit="MW" seq-num="1"/>
    </ProfileData>
    <ProfileData profile-role="AC01">
      <Data period-from="22" period-to="23" value="1134" unit="MW" seq-num="1"/>
    </ProfileData>
    <ProfileData profile-role="AC02">
      <Data period-from="22" period-to="23" value="764" unit="MW" seq-num="1"/>
    </ProfileData>
    <ProfileData profile-role="AC01">
      <Data period-from="23" period-to="24" value="1168" unit="MW" seq-num="1"/>
    </ProfileData>
    <ProfileData profile-role="AC02">
      <Data period-from="23" period-to="24" value="2098" unit="MW" seq-num="1"/>
    </ProfileData>
  </Trade>
  <Trade trade-day="2022-09-27" market="VDT" delivery-duration="60" market-area="SK" area-from="SK" area-to="BE"
xmlns="http://sfera.sk/xmtrade/isot/types/IDM/2016/04">
    <TimeData datetime="2022-09-27T11:21:44.6815426+02:00" datetime-type="DTO"/>
    <ProfileData profile-role="AC01">
      <Data period-from="0" period-to="1" value="0" unit="MW" seq-num="1"/>
    </ProfileData>
    <ProfileData profile-role="AC02">
      <Data period-from="0" period-to="1" value="0" unit="MW" seq-num="1"/>
    </ProfileData>
    <ProfileData profile-role="AC01">
      <Data period-from="1" period-to="2" value="0" unit="MW" seq-num="1"/>
    </ProfileData>
    <ProfileData profile-role="AC02">
      <Data period-from="1" period-to="2" value="0" unit="MW" seq-num="1"/>
    </ProfileData>
    <ProfileData profile-role="AC01">
      <Data period-from="2" period-to="3" value="0" unit="MW" seq-num="1"/>
    </ProfileData>
    <ProfileData profile-role="AC02">
      <Data period-from="2" period-to="3" value="0" unit="MW" seq-num="1"/>
    </ProfileData>
    <!--... missing periods ...-->
    <ProfileData profile-role="AC01">
      <Data period-from="21" period-to="22" value="418" unit="MW" seq-num="1"/>
    </ProfileData>
    <ProfileData profile-role="AC02">
      <Data period-from="21" period-to="22" value="684" unit="MW" seq-num="1"/>
    </ProfileData>
    <ProfileData profile-role="AC01">
      <Data period-from="22" period-to="23" value="0" unit="MW" seq-num="1"/>
    </ProfileData>
    <ProfileData profile-role="AC02">
      <Data period-from="22" period-to="23" value="764" unit="MW" seq-num="1"/>
    </ProfileData>
    <ProfileData profile-role="AC01">
      <Data period-from="23" period-to="24" value="0" unit="MW" seq-num="1"/>
    </ProfileData>
    <ProfileData profile-role="AC02">
      <Data period-from="23" period-to="24" value="845" unit="MW" seq-num="1"/>
    </ProfileData>
  </Trade>
</ISOTEDATA>

```

Example 29

Response containing available cross-border capacities data (data sample)

4.5 Administration of IDA orders

Market participant DAM order administration is carried out through operations of order reception and availability registered in ISOT via [IdaOrders](#) web service.

4.5.1 Processing level

Market participants enter their orders into ISOT by the deadline for order registration for specific auction at the latest. Orders can be entered into the system in advance, even several days in advance.

Market participant can register unlimited number of sale orders and unlimited number of purchase orders for a single trading day. Trading period within intraday auctions is specified to 15 minutes. Order can contain following characteristics:

- Standard order (order containing maximum of 25 blocks without the possibility to define total acceptance of block no. 1). This order type is defined by element *block-order="N"*.
- Block order with one of the following types:
 - simple profile block order with possibility to fill up one block containing the quantity for maximum of 96 (92/100 in case of clock change day) periods with definition of one weighted-average price, defined by *block-order="A" a block-type="SB"*.

In the case that market participant, using the modification of existing order, replaces already existing order, or removes the order from the system, it is not allowed to return to the previous version of the order i.e. not even in case that the original order was valid and the new order is invalid.

In case of invalid order, user is required to remove reasons for its invalidity by replacement with a new version or by deleting the existing order and creation of new one respectively. Orders non-compliant with the check at submission (invalid) shall be removed and will not enter the matching process.

Removal of already entered and accepted orders is carried out through submission of a new order with null values in the first block (paired values of amount/price).

4.5.2 Reception of orders (E-09_01)

Reception of orders is carried out by request for order submission in *ISOTEDATA.851* structure (message-code=851) and by response in *RESPONSE.812* structure (indication of success/fail) and *ISOTEDATA.813* structure (description of order registered in the system).



Figure 29 Schéma příjmu objednávky VDA

ISOTEDATA.811

The structure contains message-code=811 attribute in the header and is filled out in accordance with [order structure](#). Only a single order can be concurrently entered, i.e. submission of multiple orders is carried out through multiple calls.

```
<ISOTEDATA id="1" message-code="851" date-time="2023-12-01T00:00:00" dtd-version="1" dtd-
release="1" answer-required="false"
xmlns="http://sfera.sk/ws/xmtrade/isot/interfaces/orders/types/2009/04/01">
  <SenderIdentification id="24X-ENTRADE-SK-9" coding-scheme="15" />
  <ReceiverIdentification id="24X-OT-SK-----V" coding-scheme="15" />
  <Trade trade-day="2023-12-01" auction-id="IDA1" trade-type="P" block-order="N" market-
area="SK" market="IDA" delivery-duration="15" sett-curr="EUR">
    <ProfileData profile-role="BC01">
      <Data period="1" value="100.0" unit="MW" splitting="A" />
      <Data period="2" value="100.0" unit="MW" splitting="A" />
      <Data period="3" value="100.0" unit="MW" splitting="A" />
      <Data period="4" value="100.0" unit="MW" splitting="A" />
      <Data period="5" value="100.0" unit="MW" splitting="A" />
      <Data period="6" value="100.0" unit="MW" splitting="N" />
      <Data period="7" value="100.0" unit="MW" splitting="N" />
      <Data period="8" value="100.0" unit="MW" splitting="N" />
      <Data period="9" value="100.0" unit="MW" splitting="N" />
      <Data period="10" value="100.0" unit="MW" splitting="N" />
      <Data period="11" value="100.0" unit="MW" splitting="N" />
      <Data period="12" value="100.0" unit="MW" splitting="N" />
      <Data period="13" value="100.0" unit="MW" splitting="N" />
      <Data period="14" value="100.0" unit="MW" splitting="N" />
      <Data period="15" value="100.0" unit="MW" splitting="N" />
      <Data period="16" value="100.0" unit="MW" splitting="N" />
      <Data period="17" value="100.0" unit="MW" splitting="N" />
      <Data period="18" value="100.0" unit="MW" splitting="N" />
      <Data period="19" value="100.0" unit="MW" splitting="N" />
      <Data period="20" value="100.0" unit="MW" splitting="N" />
    </ProfileData>
    <ProfileData profile-role="BP01">
      <Data period="1" value="15.00" unit="EUR" splitting="A" />
      <Data period="2" value="15.00" unit="EUR" splitting="A" />
      <Data period="3" value="15.00" unit="EUR" splitting="A" />
      <Data period="4" value="15.00" unit="EUR" splitting="A" />
      <Data period="5" value="15.00" unit="EUR" splitting="A" />
      <Data period="6" value="15.00" unit="EUR" splitting="N" />
      <Data period="7" value="15.00" unit="EUR" splitting="N" />
      <Data period="8" value="15.00" unit="EUR" splitting="N" />
      <Data period="9" value="15.00" unit="EUR" splitting="N" />
      <Data period="10" value="15.00" unit="EUR" splitting="N" />
      <Data period="11" value="15.00" unit="EUR" splitting="N" />
      <Data period="12" value="15.00" unit="EUR" splitting="N" />
      <Data period="13" value="15.00" unit="EUR" splitting="N" />
      <Data period="14" value="15.00" unit="EUR" splitting="N" />
      <Data period="15" value="15.00" unit="EUR" splitting="N" />
      <Data period="16" value="15.00" unit="EUR" splitting="N" />
      <Data period="17" value="15.00" unit="EUR" splitting="N" />
      <Data period="18" value="15.00" unit="EUR" splitting="N" />
      <Data period="19" value="15.00" unit="EUR" splitting="N" />
      <Data period="20" value="15.00" unit="EUR" splitting="N" />
    </ProfileData>
    <Party id="24X-ENTRADE-SK-9" role="TO" />
  </Trade>
</ISOTEDATA>
```

Example 30

Submission of standard IDA order for sale

```

<ISOTEDATA id="1" message-code="851" date-time="2023-12-01T00:00:00" dtd-version="1" dtd-
release="1" answer-required="false"
xmlns="http://sfera.sk/ws/xmtrade/isot/interfaces/orders/types/2009/04/01">
  <SenderIdentification id="24X-ENTRADE-SK-9" coding-scheme="15" />
  <ReceiverIdentification id="24X-OT-SK-----V" coding-scheme="15" />
  <Trade trade-day="2023-12-01" auction-id="IDA1" trade-type="P" block-order="A" block-
type="SB" market-area="SK" market="IDA" delivery-duration="15" sett-curr="EUR">
    <ProfileData profile-role="BC01">
      <Data period="1" value="100.0" unit="MW" splitting="A" />
      <Data period="2" value="100.0" unit="MW" splitting="A" />
      <Data period="3" value="100.0" unit="MW" splitting="A" />
      <Data period="4" value="100.0" unit="MW" splitting="A" />
      <Data period="5" value="100.0" unit="MW" splitting="A" />
      <Data period="6" value="100.0" unit="MW" splitting="N" />
      <Data period="7" value="100.0" unit="MW" splitting="N" />
      <Data period="8" value="100.0" unit="MW" splitting="N" />
      <Data period="9" value="100.0" unit="MW" splitting="N" />
      <Data period="10" value="100.0" unit="MW" splitting="N" />
      <Data period="11" value="100.0" unit="MW" splitting="N" />
      <Data period="12" value="100.0" unit="MW" splitting="N" />
    </ProfileData>
    <ProfileData profile-role="BP01">
      <Data period="1" value="15.00" unit="EUR" splitting="A" />
      <Data period="2" value="15.00" unit="EUR" splitting="A" />
      <Data period="3" value="15.00" unit="EUR" splitting="A" />
      <Data period="4" value="15.00" unit="EUR" splitting="A" />
      <Data period="5" value="15.00" unit="EUR" splitting="A" />
      <Data period="6" value="15.00" unit="EUR" splitting="N" />
      <Data period="7" value="15.00" unit="EUR" splitting="N" />
      <Data period="8" value="15.00" unit="EUR" splitting="N" />
      <Data period="9" value="15.00" unit="EUR" splitting="N" />
      <Data period="10" value="15.00" unit="EUR" splitting="N" />
      <Data period="11" value="15.00" unit="EUR" splitting="N" />
      <Data period="12" value="15.00" unit="EUR" splitting="N" />
    </ProfileData>
    <Party id="24X-ENTRADE-SK-9" role="TO" />
  </Trade>
</ISOTEDATA>

```

Example 31 Submission of simple block IDA order for sale

RESPONSE.812

In case of successful or failed order processing, response is returned in accordance with specification of [RESPONSE](#) structure, with *message-code=812* in the header. Identification, under which the order is registered in the system, is returned in *Reason/@trade-id* attribute.

```

<RESPONSE id="cb4d980f-2f9a-4be7-96ef-850be04b214" message-code="812"
date-time="2023-12-01T13:46:26Z" dtd-version="1" dtd-release="1"
xmlns="http://sfera.sk/ws/xmtrade/isot/interfaces/ut/types/2009/04/01">
  <SenderIdentification id="24X-OT-SK-----V" coding-scheme="15" />
  <ReceiverIdentification id="24X-ENTRADE-SK-9" coding-scheme="15" />
  <Reference id="1"/>
  <Reason code="0" type="A03" trade-id="1016"/>
</RESPONSE>

```

Example 32 Response on success of IDA order submission

ISOTEDATA.813

In case of successful order processing, the structure is returned as it was registered in the system, where *message-code=813* can be found in the header. Identification and version, under which the order is registered in the system, are returned in *Trade/@id* and *Trade/@version* attribute. Own order data can be retrieved back based on this identification (see E-09_02).

```

<ISOTEDATA id="ac5e799q-2qtr-75e7-9bef-8aabc02b7f4" message-code="813"
  date-time="2023-12-01T13:46:26Z" dtd-version="1" dtd-release="1" answer-required="false"
  xmlns="http://sfera.sk/ws/xmtrade/isot/interfaces/orders/types/2009/04/01">
  <SenderIdentification id="24X-ENTRADE-SK-9" coding-scheme="15"/>
  <ReceiverIdentification id="24X-OT-SK-----V" coding-scheme="15" />
  <Reference id="1"/>
  <Trade id="1016" trade-day="2023-12-01" auction-id="IDA1" version="1" trade-type="P" block-
order="N" trade-stage="P" sett-curr="EUR" market-area="SK" market="IDA" delivery-duration="15">
  <TimeData datetime="2023-12-01T13:46:26Z" datetime-type="DTC"/>
  <ProfileData profile-role="BC01">
    <Data period="1" value="100.0" unit="MW" splitting="A"/>
    <Data period="2" value="100.0" unit="MW" splitting="A"/>
    <Data period="3" value="100.0" unit="MW" splitting="A"/>
    <Data period="4" value="100.0" unit="MW" splitting="A"/>
    <Data period="5" value="100.0" unit="MW" splitting="A"/>
    <Data period="6" value="100.0" unit="MW" splitting="N"/>
    <Data period="7" value="100.0" unit="MW" splitting="N"/>
    <Data period="8" value="100.0" unit="MW" splitting="N"/>
    <Data period="9" value="100.0" unit="MW" splitting="N"/>
    <Data period="10" value="100.0" unit="MW" splitting="N"/>
    <Data period="11" value="100.0" unit="MW" splitting="N" />
    <Data period="12" value="100.0" unit="MW" splitting="N" />
    <Data period="13" value="100.0" unit="MW" splitting="N" />
    <Data period="14" value="100.0" unit="MW" splitting="N" />
    <Data period="15" value="100.0" unit="MW" splitting="N" />
    <Data period="16" value="100.0" unit="MW" splitting="N" />
    <Data period="17" value="100.0" unit="MW" splitting="N" />
    <Data period="18" value="100.0" unit="MW" splitting="N" />
    <Data period="19" value="100.0" unit="MW" splitting="N" />
    <Data period="20" value="100.0" unit="MW" splitting="N" />
  </ProfileData>
  <ProfileData profile-role="BP01">
    <Data period="1" value="15.00" unit="EUR" splitting="A"/>
    <Data period="2" value="15.00" unit="EUR" splitting="A"/>
    <Data period="3" value="15.00" unit="EUR" splitting="A"/>
    <Data period="4" value="15.00" unit="EUR" splitting="A"/>
    <Data period="5" value="15.00" unit="EUR" splitting="A"/>
    <Data period="6" value="15.00" unit="EUR" splitting="N"/>
    <Data period="7" value="15.00" unit="EUR" splitting="N"/>
    <Data period="8" value="15.00" unit="EUR" splitting="N"/>
    <Data period="9" value="15.00" unit="EUR" splitting="N"/>
    <Data period="10" value="15.00" unit="EUR" splitting="N"/>
    <Data period="11" value="15.00" unit="EUR" splitting="N" />
    <Data period="12" value="15.00" unit="EUR" splitting="N" />
    <Data period="13" value="15.00" unit="EUR" splitting="N" />
    <Data period="14" value="15.00" unit="EUR" splitting="N" />
    <Data period="15" value="15.00" unit="EUR" splitting="N" />
    <Data period="16" value="15.00" unit="EUR" splitting="N" />
    <Data period="17" value="15.00" unit="EUR" splitting="N" />
    <Data period="18" value="15.00" unit="EUR" splitting="N" />
    <Data period="19" value="15.00" unit="EUR" splitting="N" />
    <Data period="20" value="15.00" unit="EUR" splitting="N" />
  </ProfileData>
  <Party id="24X-ENTRADE-SK-9" role="TO"/>
</Trade>
</ISOTEDATA>

```

Example 33 Response with IDA order description

4.5.3 Removal of orders (E-09_01)

Removal of order is carried out by submission of specific order in *ISOTEDATA.851* structure (message-code=851) containing null values for amount and price in the first block for all periods of a given trading day. Response to order removal is returned in *RESPONSE.812* structure (indication of success/failure) and *ISOTEDATA.813* structure (description of order that was removed from the system).



Figure 30 Schema for IDA order removal

ISOTEDATA.851

The structure contains *message-code=851* attribute in the header and is filled out in accordance with [order structure](#) specification, where only the 1. block is entered containing null values for amount and price. Request can be entered for removal of orders for specific trading day and auction (*trade-day and auction-id* attribute), removal of specific auction and order type (*trade-day* and *trade-type* attributes) or removal of specific order via order identification of relevant order (*id* attribute returned in responses at order submission).

```

<ISOTEDATA id="1" message-code="851" date-time="2023-12-01T00:00:00" dtd-version="1" dtd-
release="1" answer-required="false"
xmlns="http://sfera.sk/ws/xmtrade/isot/interfaces/orders/types/2009/04/01">
  <SenderIdentification id="24X-ENTRADE-SK-9" coding-scheme="15" />
  <ReceiverIdentification id="24X-OT-SK-----V" coding-scheme="15" />
  <Trade id="1016" trade-day="2023-12-01" auction-id="IDA1" trade-type="P" market-area="SK"
market="IDA" delivery-duration="15" sett-curr="EUR">
    <ProfileData profile-role="BC01">
      <Data period="1" value="0.0" unit="MW" splitting="A"/>
      <Data period="2" value="0.0" unit="MW" splitting="A"/>
      <Data period="3" value="0.0" unit="MW" splitting="A"/>
      <Data period="4" value="0.0" unit="MW" splitting="A"/>
      <Data period="5" value="0.0" unit="MW" splitting="A"/>
      <Data period="6" value="0.0" unit="MW" splitting="A"/>
      <Data period="7" value="0.0" unit="MW" splitting="A"/>
      <Data period="8" value="0.0" unit="MW" splitting="A"/>
      <Data period="9" value="0.0" unit="MW" splitting="A"/>
      <Data period="10" value="0.0" unit="MW" splitting="A"/>
      <Data period="11" value="0.0" unit="MW" splitting="A"/>
      <Data period="12" value="0.0" unit="MW" splitting="A"/>
      <Data period="13" value="0.0" unit="MW" splitting="A"/>
      <Data period="14" value="0.0" unit="MW" splitting="A"/>
      <Data period="15" value="0.0" unit="MW" splitting="A"/>
      <Data period="16" value="0.0" unit="MW" splitting="A"/>
      <Data period="17" value="0.0" unit="MW" splitting="A"/>
      <Data period="18" value="0.0" unit="MW" splitting="A"/>
      <Data period="19" value="0.0" unit="MW" splitting="A"/>
      <Data period="20" value="0.0" unit="MW" splitting="A"/>
      <Data period="21" value="0.0" unit="MW" splitting="A"/>
      <Data period="22" value="0.0" unit="MW" splitting="A"/>
      <Data period="23" value="0.0" unit="MW" splitting="A"/>
      <Data period="24" value="0.0" unit="MW" splitting="A"/>
      <Data period="25" value="0.0" unit="MW" splitting="A"/>
      .....
      <Data period="94" value="0.0" unit="MW" splitting="A"/>
      <Data period="95" value="0.0" unit="MW" splitting="A"/>
      <Data period="96" value="0.0" unit="MW" splitting="A"/>
    </ProfileData>
    <ProfileData profile-role="BP01">
      <Data period="1" value="0.0" unit="EUR" splitting="A"/>
      <Data period="2" value="0.0" unit="EUR" splitting="A"/>
      <Data period="3" value="0.0" unit="EUR" splitting="A"/>
      <Data period="4" value="0.0" unit="EUR" splitting="A"/>
      <Data period="5" value="0.0" unit="EUR" splitting="A"/>
      <Data period="6" value="0.0" unit="EUR" splitting="A"/>
      <Data period="7" value="0.0" unit="EUR" splitting="A"/>
      <Data period="8" value="0.0" unit="EUR" splitting="A"/>
      <Data period="9" value="0.0" unit="EUR" splitting="A"/>
      <Data period="10" value="0.0" unit="EUR" splitting="A"/>
      <Data period="11" value="0.0" unit="EUR" splitting="A"/>
      <Data period="12" value="0.0" unit="EUR" splitting="A"/>
      <Data period="13" value="0.0" unit="EUR" splitting="A"/>
      <Data period="14" value="0.0" unit="EUR" splitting="A"/>
      <Data period="15" value="0.0" unit="EUR" splitting="A"/>
      <Data period="16" value="0.0" unit="EUR" splitting="A"/>
      <Data period="17" value="0.0" unit="EUR" splitting="A"/>
      <Data period="18" value="0.0" unit="EUR" splitting="A"/>
      <Data period="19" value="0.0" unit="EUR" splitting="A"/>
      <Data period="20" value="0.0" unit="EUR" splitting="A"/>
      <Data period="21" value="0.0" unit="EUR" splitting="A"/>
      <Data period="22" value="0.0" unit="EUR" splitting="A"/>
      <Data period="23" value="0.0" unit="EUR" splitting="A"/>
      <Data period="24" value="0.0" unit="EUR" splitting="A"/>
      <Data period="25" value="0.0" unit="EUR" splitting="A"/>
      .....
      <Data period="94" value="0.0" unit="EUR" splitting="A"/>
      <Data period="95" value="0.0" unit="EUR" splitting="A"/>
      <Data period="96" value="0.0" unit="EUR" splitting="A"/>
    </ProfileData>
  <Party id="24X-ENTRADE-SK-9" role="TO" />
</Trade>
</ISOTEDATA>

```

Example 34**Removal of specific IDA order for sale**

RESPONSE.812

In accordance with specification of [RESPONSE](#) structure, response is given in case of successful or unsuccessful order processing. In this case message-code=812 can be found in the header.

```
<RESPONSE id="cb4d980f-2f9a-4be7-96ef-850be04b214" message-code="812"
  date-time="2023-12-01T13:46:26Z" dtd-version="1" dtd-release="1"
  xmlns="http://sfera.sk/ws/xmtrade/isot/interfaces/ut/types/2009/04/01">
  <SenderIdentification id="24X-OT-SK-----V" coding-scheme="15" />
  <ReceiverIdentification id="24X-ENTRADE-SK-9" coding-scheme="15" />
  <Reference id="1"/>
  <Reason code="0" type="A03"/>
</RESPONSE>
```

Example 35 Response on success of IDA order removal**ISOTEDATA.813**

In case of successful order removal, the original order that was removed from the system will be returned. Message-code=813 can be found in the header.

```
<ISOTEDATA id="ac5e799q-2qtr-75e7-9bef-8aabc02b7f4" message-code="813"
  date-time="2023-12-01T13:46:26Z" dtd-version="1" dtd-release="1" answer-required="false"
  xmlns="http://sfera.sk/ws/xmtrade/isot/interfaces/orders/types/2009/04/01">
  <SenderIdentification id="24X-ENTRADE-SK-9" coding-scheme="15"/>
  <ReceiverIdentification id="24X-OT-SK-----V" coding-scheme="15" />
  <Reference id="1"/>
  <Trade id="1016" trade-day="2023-12-01" auction-id="IDA1" version="1" trade-type="P" block-
order="N" trade-stage="P" sett-curr="EUR" market-area="SK" market="IDA" delivery-duration="15">
  <TimeData datetime="2023-12-01T13:46:26Z" datetime-type="DTC"/>
  <ProfileData profile-role="BC01">
  <Data period="1" value="100.0" unit="MWH" splitting="A"/>
  <Data period="2" value="100.0" unit="MWH" splitting="A"/>
  <Data period="3" value="100.0" unit="MWH" splitting="A"/>
  <Data period="4" value="100.0" unit="MWH" splitting="A"/>
  <Data period="5" value="100.0" unit="MWH" splitting="A"/>
  <Data period="6" value="100.0" unit="MWH" splitting="N"/>
  <Data period="7" value="100.0" unit="MWH" splitting="N"/>
  <Data period="8" value="100.0" unit="MWH" splitting="N"/>
  <Data period="9" value="100.0" unit="MWH" splitting="N"/>
  <Data period="10" value="100.0" unit="MWH" splitting="N"/>
  </ProfileData>
  <ProfileData profile-role="BP01">
  <Data period="1" value="15.00" unit="EUR" splitting="A"/>
  <Data period="2" value="15.00" unit="EUR" splitting="A"/>
  <Data period="3" value="15.00" unit="EUR" splitting="A"/>
  <Data period="4" value="15.00" unit="EUR" splitting="A"/>
  <Data period="5" value="15.00" unit="EUR" splitting="A"/>
  <Data period="6" value="15.00" unit="EUR" splitting="N"/>
  <Data period="7" value="15.00" unit="EUR" splitting="N"/>
  <Data period="8" value="15.00" unit="EUR" splitting="N"/>
  <Data period="9" value="15.00" unit="EUR" splitting="N"/>
  <Data period="10" value="15.00" unit="EUR" splitting="N"/>
  </ProfileData>
  <Party id="24X-ENTRADE-SK-9" role="TO"/>
  </Trade>
</ISOTEDATA>
```

Example 36 Response with description of removed IDA order**4.5.4 Order modification (E-09_01)**

Modification of order is carried out by entry of specific order that is to be modified in *ISOTEDATA.811* structure (message-code=851) containing updated values for amount and price for desired trading periods of a given trading day. Response to order removal is returned in *RESPONSE.812* structure (indication of success/failure) and *ISOTEDATA.813* structure (description of modified order saved in the system). Order header modification is not possible. In order to modify the order header (i.e. type or direction), delete the existing order and submit a new one with required parameters.



Figure 31 Schéma modifikácie objednávky ÚT

ISOTEDATA.851

The structure contains *message-code=851* attribute in the header and is filled out in accordance with [order structure](#) specification. The order that is to be modified must be identified by specification of its ID in the attribute *Trade/id*. Only a single order can be concurrently modified, i.e. modification of multiple orders is carried out through multiple calls.

```

<ISOTEDATA id="1" message-code="851" date-time="2023-12-01T00:00:00" dtd-version="1" dtd-
release="1" answer-required="false"
xmlns="http://sfera.sk/ws/xmtrade/isot/interfaces/orders/types/2009/04/01">
  <SenderIdentification id="24X-ENTRADE-SK-9" coding-scheme="15" />
  <ReceiverIdentification id="24X-OT-SK-----V" coding-scheme="15" />
  <Trade id="1016" trade-day="2023-12-01" auction-id="IDA1" trade-type="P" block-order="N"
market-area="SK" market="IDA" delivery-duration="15" sett-curr="EUR">
  <ProfileData profile-role="BC01">
    <Data period="1" value="10.0" unit="MW" splitting="A"/>
    <Data period="2" value="10.0" unit="MW" splitting="A"/>
    <Data period="3" value="10.0" unit="MW" splitting="A"/>
    <Data period="4" value="10.0" unit="MW" splitting="A"/>
    <Data period="5" value="20.0" unit="MW" splitting="A"/>
    <Data period="6" value="20.0" unit="MW" splitting="A"/>
    <Data period="7" value="20.0" unit="MW" splitting="A"/>
    <Data period="8" value="10.0" unit="MW" splitting="A"/>
    <Data period="9" value="10.0" unit="MW" splitting="A"/>
    <Data period="10" value="10.0" unit="MW" splitting="A"/>
    <Data period="11" value="10.0" unit="MW" splitting="A"/>
    <Data period="12" value="10.0" unit="MW" splitting="A"/>
    <Data period="13" value="10.0" unit="MW" splitting="A"/>
    <Data period="14" value="10.0" unit="MW" splitting="A"/>
    <Data period="15" value="20.0" unit="MW" splitting="A"/>
    <Data period="16" value="20.0" unit="MW" splitting="A"/>
    <Data period="17" value="20.0" unit="MW" splitting="A"/>
    <Data period="18" value="20.0" unit="MW" splitting="A"/>
    <Data period="19" value="20.0" unit="MW" splitting="A"/>
    <Data period="20" value="20.0" unit="MW" splitting="A"/>
    <Data period="21" value="10.0" unit="MW" splitting="A"/>
    <Data period="22" value="10.0" unit="MW" splitting="A"/>
    <Data period="23" value="10.0" unit="MW" splitting="A"/>
    <Data period="24" value="10.0" unit="MW" splitting="A"/>
    <Data period="25" value="10.0" unit="MW" splitting="A"/>
    ...
    <Data period="95" value="12.0" unit="MW" splitting="A"/>
    <Data period="96" value="12.0" unit="MW" splitting="A"/>
  </ProfileData>
  <ProfileData profile-role="BP01">
    <Data period="1" value="50.0" unit="EUR" splitting="A"/>
    <Data period="2" value="50.0" unit="EUR" splitting="A"/>
    <Data period="3" value="50.0" unit="EUR" splitting="A"/>
    <Data period="4" value="50.0" unit="EUR" splitting="A"/>
    <Data period="5" value="50.0" unit="EUR" splitting="A"/>
    <Data period="6" value="50.0" unit="EUR" splitting="A"/>
    <Data period="7" value="50.0" unit="EUR" splitting="A"/>
    <Data period="8" value="50.0" unit="EUR" splitting="A"/>
    <Data period="9" value="50.0" unit="EUR" splitting="A"/>
    <Data period="10" value="50.0" unit="EUR" splitting="A"/>
    <Data period="11" value="50.0" unit="EUR" splitting="A"/>
    <Data period="12" value="50.0" unit="EUR" splitting="A"/>
    <Data period="13" value="50.0" unit="EUR" splitting="A"/>
    <Data period="14" value="50.0" unit="EUR" splitting="A"/>
    <Data period="15" value="50.0" unit="EUR" splitting="A"/>
    <Data period="16" value="50.0" unit="EUR" splitting="A"/>
    <Data period="17" value="50.0" unit="EUR" splitting="A"/>
    <Data period="18" value="50.0" unit="EUR" splitting="A"/>
    <Data period="19" value="50.0" unit="EUR" splitting="A"/>
    <Data period="20" value="50.0" unit="EUR" splitting="A"/>
    <Data period="21" value="50.0" unit="EUR" splitting="A"/>
    <Data period="22" value="50.0" unit="EUR" splitting="A"/>
    <Data period="23" value="50.0" unit="EUR" splitting="A"/>
    <Data period="24" value="50.0" unit="EUR" splitting="A"/>
    <Data period="25" value="10.0" unit=" EUR " splitting="A"/>
    ...
    <Data period="95" value="30.0" unit="EUR" splitting="A"/>
    <Data period="96" value="30.0" unit="EUR" splitting="A"/>
  </ProfileData>
  <Party id="24X-ENTRADE-SK-9" role="TO" />
</Trade>
</ISOTEDATA>

```

Example 37

IDA order modification

RESPONSE.812

In accordance with specification of [RESPONSE](#) structure, response is given in case of successful or unsuccessful order processing. In this case message-code=812 can be found in the header.

```
<RESPONSE id="cb4d980f-2f9a-4be7-96ef-850be04b214" message-code="812"
  date-time="2023-12-01T13:46:26Z" dtd-version="1" dtd-release="1"
  xmlns="http://sfera.sk/ws/xmtrade/isot/interfaces/ut/types/2009/04/01">
  <SenderIdentification id="24X-OT-SK-----V" coding-scheme="15" />
  <ReceiverIdentification id="24X-ENTRADE-SK-9" coding-scheme="15" />
  <Reference id="1"/>
  <Reason code="0" type="A03"/>
</RESPONSE>
```

Example 38 Response on success of IDA order modification

ISOTEDATA.813

In case of successful order modification, the successfully modified order will be returned with increased version in comparison to original order. Message-code=813 can be found in the header. Within the Trade/@id and Trade/@version attributes are returned ID and version under which the order is saved. Based on these data it is possible to request the own order data (see E-09_02).

```

<ISOTEDATA id="ac5e799q-2qtr-75e7-9bef-8aabc02b7f4" message-code="813"
  date-time="2023-12-01T13:46:26Z" dtd-version="1" dtd-release="1" answer-required="false"
  xmlns="http://sfera.sk/ws/xmtrade/isot/interfaces/orders/types/2009/04/01">
  <SenderIdentification id="24X-ENTRADE-SK-9" coding-scheme="15"/>
  <ReceiverIdentification id="24X-OT-SK-----V" coding-scheme="15" />
  <Reference id="1"/>
  <Trade id="1016" trade-day="2023-12-01" auction-id="IDA1" version="2" trade-type="P" block-
order="N" trade-stage="P" sett-curr="EUR" market-area="SK" market="IDA" delivery-duration="15" >
  <TimeData datetime="2023-12-01T13:46:26Z" datetime-type="DTC"/>
  <ProfileData profile-role="BC01">
    <Data period="1" value="10.0" unit="MW" splitting="A"/>
    <Data period="2" value="10.0" unit="MW" splitting="A"/>
    <Data period="3" value="10.0" unit="MW" splitting="A"/>
    <Data period="4" value="10.0" unit="MW" splitting="A"/>
    <Data period="5" value="20.0" unit="MW" splitting="A"/>
    <Data period="6" value="20.0" unit="MW" splitting="A"/>
    <Data period="7" value="20.0" unit="MW" splitting="A"/>
    <Data period="8" value="10.0" unit="MW" splitting="A"/>
    <Data period="9" value="10.0" unit="MW" splitting="A"/>
    <Data period="10" value="10.0" unit="MW" splitting="A"/>
    <Data period="11" value="10.0" unit="MW" splitting="A"/>
    <Data period="12" value="10.0" unit="MW" splitting="A"/>
    <Data period="13" value="10.0" unit="MW" splitting="A"/>
    <Data period="14" value="10.0" unit="MW" splitting="A"/>
    <Data period="15" value="20.0" unit="MW" splitting="A"/>
    <Data period="16" value="20.0" unit="MW" splitting="A"/>
    <Data period="17" value="20.0" unit="MW" splitting="A"/>
    <Data period="18" value="20.0" unit="MW" splitting="A"/>
    <Data period="19" value="20.0" unit="MW" splitting="A"/>
    <Data period="20" value="20.0" unit="MW" splitting="A"/>
    <Data period="21" value="10.0" unit="MW" splitting="A"/>
    <Data period="22" value="10.0" unit="MW" splitting="A"/>
    <Data period="23" value="10.0" unit="MW" splitting="A"/>
    <Data period="24" value="10.0" unit="MW" splitting="A"/>
    <Data period="25" value="10.0" unit="MW" splitting="A"/>
    ...
    <Data period="95" value="12.0" unit="MW" splitting="A"/>
    <Data period="96" value="12.0" unit="MW" splitting="A"/>
  </ProfileData>
  <ProfileData profile-role="BP01">
    <Data period="1" value="50.0" unit="EUR" splitting="A"/>
    <Data period="2" value="50.0" unit="EUR" splitting="A"/>
    <Data period="3" value="50.0" unit="EUR" splitting="A"/>
    <Data period="4" value="50.0" unit="EUR" splitting="A"/>
    <Data period="5" value="50.0" unit="EUR" splitting="A"/>
    <Data period="6" value="50.0" unit="EUR" splitting="A"/>
    <Data period="7" value="50.0" unit="EUR" splitting="A"/>
    <Data period="8" value="50.0" unit="EUR" splitting="A"/>
    <Data period="9" value="50.0" unit="EUR" splitting="A"/>
    <Data period="10" value="50.0" unit="EUR" splitting="A"/>
    <Data period="11" value="50.0" unit="EUR" splitting="A"/>
    <Data period="12" value="50.0" unit="EUR" splitting="A"/>
    <Data period="13" value="50.0" unit="EUR" splitting="A"/>
    <Data period="14" value="50.0" unit="EUR" splitting="A"/>
    <Data period="15" value="50.0" unit="EUR" splitting="A"/>
    <Data period="16" value="50.0" unit="EUR" splitting="A"/>
    <Data period="17" value="50.0" unit="EUR" splitting="A"/>
    <Data period="18" value="50.0" unit="EUR" splitting="A"/>
    <Data period="19" value="50.0" unit="EUR" splitting="A"/>
    <Data period="20" value="50.0" unit="EUR" splitting="A"/>
    <Data period="21" value="50.0" unit="EUR" splitting="A"/>
    <Data period="22" value="50.0" unit="EUR" splitting="A"/>
    <Data period="23" value="50.0" unit="EUR" splitting="A"/>
    <Data period="24" value="50.0" unit="EUR" splitting="A"/>
    <Data period="25" value="10.0" unit=" EUR " splitting="A"/>
    ...
    <Data period="95" value="30.0" unit="EUR" splitting="A"/>
    <Data period="96" value="30.0" unit="EUR" splitting="A"/>
  </ProfileData>
  <Party id="24X-ENTRADE-SK-9" role="TO"/>
</Trade>
</ISOTEDATA>

```

Example 39

Response with description of modified IDA order

4.5.5 Provision of orders (E-09_02)

Provision of orders is carried out by request for order retrieval in *CDSREQ.831* structure (message-code=831) and response in *RESPONSE.832* structure (indication of success/failure) and *ISOTEDATA.833 structure* (description of order registered in the system).

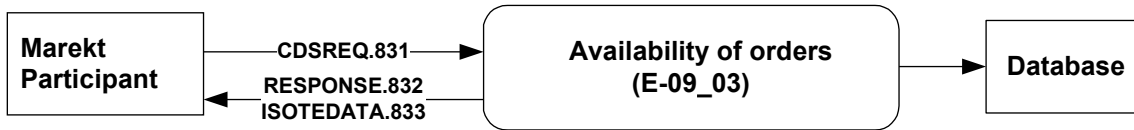

Figure 32 IDA order provision schema

CDSREQ.831

Request can be formulated either for specific auction (trade-day and auction-id) or for specific order (id and version) and is filled out according to the specification of *CDSREQ* structure. Order identification has precedence over trading day and auction.

```

<CDSREQ id="4a6s5d45f" message-code="831" date-time="2023-12-01T01:18:33" dtd-version="1" dtd-release="1" xmlns="http://sfera.sk/ws/xmtrade/isot/interfaces/ut/types/2009/04/01">
  <SenderIdentification id="24X-ENTRADE-SK-9" coding-scheme="15"/>
  <ReceiverIdentification id="24X-OT-SK-----V" coding-scheme="15"/>
  <Trade trade-day="2023-12-01" auction-id="IDA1"/>
</CDSREQ>
  
```

Example 40 Request for provision of IDA orders for specific auction

RESPONSE.832

In case of successful or failed request processing, response is returned in accordance with specification of [RESPONSE](#) structure, where message-code=832 can be found in the header.

```

<RESPONSE id="a9e40366-ad70-45ac-8b36-bd8fbce5ef7" message-code="832"
  date-time="2023-12-01T14:02:36Z" dtd-version="1" dtd-release="1"
  xmlns="http://sfera.sk/ws/xmtrade/isot/interfaces/ut/types/2009/04/01">
  <SenderIdentification id="24X-OT-SK-----V" coding-scheme="15"/>
  <ReceiverIdentification id="24X-ENTRADE-SK-9" coding-scheme="15" />
  <Reference id="4a6s5d45f"/>
  <Reason code="0" type="A03"/>
</RESPONSE>
  
```

Example 41 Response on success of IDA order data provision for specific auction

ISOTEDATA.833

In case of successful request processing, the structure is returned as it was registered in the system and message-code=833 can be found in the header. Identification and version, under which the order is registered in the system, are returned in *Trade/@id* and *Trade/@version* attribute. If there is a single purchase order and a single sale order registered in the system for a given trading day and auction, return structure of request for specific trading day contains two orders (either valid or invalid)

```
<ISOTEDATA id="1" message-code="833" date-time="2009-07-03T14:02:36Z"
  dtd-version="1" dtd-release="1" answer-required="false"
  xmlns="http://sfera.sk/ws/xmtrade/isot/interfaces/orders/types/2009/04/01">
  <SenderIdentification id="24X-OT-SK-----V 11XKORLEAINVESTY" coding-scheme="15"/>
  <ReceiverIdentification id="24X-ENTRADE-SK-9" coding-scheme="15"/>
  <Reference id="4a6s5d45f"/>
  <Trade id="123" trade-day="2023-12-01" auction-id="IDA1" trade-type="P" block-order="N" trade-
  stage="P" sett-curr="EUR" market-area="SK" market="IDA" delivery-duration="15">
  <TimeData datetime="2023-12-01T09:00:43Z" datetime-type="DTC"/>
  <ProfileData profile-role="BC01">
  <Data period="1" value="5.0" unit="MW" splitting="A"/>
  <Data period="2" value="5.0" unit="MW" splitting="A"/>
  <Data period="3" value="5.0" unit="MW" splitting="A"/>
  <Data period="4" value="5.0" unit="MW" splitting="A"/>
  <Data period="5" value="5.0" unit="MW" splitting="A"/>
  <Data period="6" value="5.0" unit="MW" splitting="A"/>
  <Data period="7" value="5.0" unit="MW" splitting="A"/>
  <Data period="8" value="5.0" unit="MW" splitting="A"/>
  <Data period="9" value="5.0" unit="MW" splitting="A"/>
  <Data period="10" value="5.0" unit="MW" splitting="A"/>
  </ProfileData>
  <ProfileData profile-role="BP01">
  <Data period="1" value="24.00" unit="EUR" splitting="A"/>
  <Data period="2" value="24.00" unit="EUR" splitting="A"/>
  <Data period="3" value="24.00" unit="EUR" splitting="A"/>
  <Data period="4" value="24.00" unit="EUR" splitting="A"/>
  <Data period="5" value="24.00" unit="EUR" splitting="A"/>
  <Data period="6" value="24.00" unit="EUR" splitting="A"/>
  <Data period="7" value="24.00" unit="EUR" splitting="A"/>
  <Data period="8" value="24.00" unit="EUR" splitting="A"/>
  <Data period="9" value="24.00" unit="EUR" splitting="A"/>
  <Data period="10" value="24.00" unit="EUR" splitting="A"/>
  </ProfileData>
  <Party id="" role="TO"/>
  </Trade>
</ISOTEDATA>
```

Example 42 Response containing IDA orders for specific auction

4.6 DM results and evaluations

Results and evaluations of day-ahead market are available for market participants via operations for DM results and evaluation retrieval for every hour or a whole day.

4.6.1 Processing level

Results of day-ahead market are available immediately after order matching and contain accepted amount and final marginal price (system or area price). Market participant is notified about results availability via ISOT system.

Evaluations of day-ahead market are available immediately after clearing of day-ahead market in the form of summary day-ahead evaluation as well as detailed evaluation per hours. Evaluations contain market organizer obligations and receivables towards a market participant. (receivables are stated with a negative sign). Market participant is notified about evaluations availability via ISOT system. Results of day-ahead market are made available in ISOT.

4.6.2 Notification of results for market participants (E-03_02)

Notification of results for entities is carried out by request in *CDSREQ.941* structure (message-code=941) and response with data in *RESPONSE.942* and *ISOTEDATA.943* structure.



Figure 33 Notification schema of DM results for market participant

CDSREQ.941

Request is formulated for specific trading day (trade-day) and is filled out in accordance with the specification of [CDSREQ](#) structure.

```

<CDSREQ id="45t" message-code="941" date-time="2014-09-19T01:18:33"
  dtd-version="1" dtd-release="1"
  xmlns="http://sfera.sk/ws/xmtrade/isot/interfaces/ut/types/2009/04/01">
  <SenderIdentification id="24XDSO-----Q" coding-scheme="15"/>
  <ReceiverIdentification id="24X-OT-SK-----V" coding-scheme="15"/>
  <Trade trade-day="2009-09-21"/>
</CDSREQ>
  
```

Example 43 Request for retrieval of results for specific day

RESPONSE.942

In case of successful or failed request processing, response is returned in accordance with specification of [RESPONSE](#) structure, where message-code=942 can be found in the header.

```

<RESPONSE id="bd12362f-361b-4085-ade0-9ed678efff1" message-code="942"
  date-time="2009-07-03T14:11:43Z" dtd-version="1" dtd-release="1"
  xmlns="http://sfera.sk/ws/xmtrade/isot/interfaces/ut/types/2009/04/01">
  <SenderIdentification id="24X-OT-SK-----V" coding-scheme="15"/>
  <ReceiverIdentification id="24XDSO-----Q" coding-scheme="15"/>
  <Reference id="45t"/>
  <Reason code="0" type="A03"/>
</RESPONSE>
  
```

Example 44 Response on success of results retrieval for a specific day

ISOTEDATA.943

In case of successful request processing, the structure of DM results is returned as it was registered in the system, where message-code=943 can be found in the header.

Within the ProfileData/@profile-role attribute are used following types of results:

- SC19 – quantity of purchased electricity for positive prices,
- SC20 – quantity of sold electricity for positive prices,
- SC92 – quantity of purchased electricity for negative prices,
- SC93 – quantity of sold electricity for negative prices,
- SP20 – marginal price.

```

<ISOTEDATA id="ec1b50c0-afe1-4f5e-b6a1-d94c365099e" message-code="943"
  date-time="2009-07-03T14:11:43Z" dtd-version="1" dtd-release="1" answer-
  required="false"
  xmlns="http://sfera.sk/ws/xmtrade/isot/interfaces/evaluations/types/2009/04/01">
  <SenderIdentification id="24X-OT-SK-----V" coding-scheme="15"/>
  <ReceiverIdentification id="24XDSO-----Q" coding-scheme="15"/>
  <Reference id="45t"/>
  <Trade trade-day="2009-09-21">
    <ProfileData profile-role="SC19">
      <Data period="1" value="50" unit="MWH"/>
      <Data period="2" value="23" unit="MWH"/>
      <Data period="3" value="65" unit="MWH"/>
      <Data period="4" value="45" unit="MWH"/>
      <Data period="5" value="12.6" unit="MWH"/>
      <Data period="6" value="65" unit="MWH"/>
      <Data period="7" value="98" unit="MWH"/>
      <Data period="8" value="78" unit="MWH"/>
      <Data period="9" value="45" unit="MWH"/>
      <Data period="10" value="41" unit="MWH"/>
      <Data period="11" value="42" unit="MWH"/>
      <Data period="12" value="12" unit="MWH"/>
      <Data period="13" value="65" unit="MWH"/>
      <Data period="14" value="31.1" unit="MWH"/>
      <Data period="15" value="32.5" unit="MWH"/>
    </ProfileData>
    <ProfileData profile-role="SC20">
      <Data period="1" value="0" unit="MWH"/>
      <Data period="2" value="64.3" unit="MWH"/>
      <Data period="3" value="0" unit="MWH"/>
      <Data period="4" value="0" unit="MWH"/>
      <Data period="5" value="0" unit="MWH"/>
      <Data period="6" value="23.4" unit="MWH"/>
      <Data period="7" value="78.9" unit="MWH"/>
      <Data period="8" value="0" unit="MWH"/>
      <Data period="9" value="0" unit="MWH"/>
      <Data period="10" value="30.1" unit="MWH"/>
      <Data period="11" value="0" unit="MWH"/>
      <Data period="12" value="0" unit="MWH"/>
      <Data period="13" value="0" unit="MWH"/>
      <Data period="14" value="50" unit="MWH"/>
      <Data period="15" value="40" unit="MWH"/>
    </ProfileData>
    <ProfileData profile-role="SP20">
      <Data period="1" value="20.45" unit="EUR"/>
      <Data period="2" value="32.45" unit="EUR"/>
      <Data period="3" value="20" unit="EUR"/>
      <Data period="4" value="20" unit="EUR"/>
      <Data period="5" value="21.65" unit="EUR"/>
      <Data period="6" value="24.95" unit="EUR"/>
      <Data period="7" value="24.35" unit="EUR"/>
      <Data period="8" value="32.65" unit="EUR"/>
      <Data period="9" value="17.65" unit="EUR"/>
      <Data period="10" value="24.87" unit="EUR"/>
      <Data period="11" value="23.98" unit="EUR"/>
      <Data period="12" value="15.45" unit="EUR"/>
      <Data period="13" value="19.87" unit="EUR"/>
      <Data period="14" value="33.54" unit="EUR"/>
      <Data period="15" value="17.65" unit="EUR"/>
    </ProfileData>
    <Party id="24XDSO-----Q" role="TO"/>
    <ResultStatus status="F"/>
  </Trade>
</ISOTEDATA>

```

Example 45 Response containing requested results

4.6.3 Notification of evaluations per hours (E-05_01)

Notification of evaluations per hours is carried out by sending a request in *CDSREQ.951* structure (message-code=951) and response with data in *RESPONSE.952* and *ISOTEDATA.953* structures.



Figure 34 Notification schema of evaluations per hours for market participant

CDSREQ.951

To be filled out in accordance with specification of [CDSREQ](#) structure. Request is formulated for specific trading day (trade-day).

```

<CDSREQ id="45t" message-code="951" date-time="2014-09-19T01:18:33"
  dtd-version="1" dtd-release="1"
  xmlns="http://sfera.sk/ws/xmtrade/isot/interfaces/ut/types/2009/04/01">
  <SenderIdentification id="24XDSO-----Q" coding-scheme="15"/>
  <ReceiverIdentification id="24X-OT-SK-----V" coding-scheme="15"/>
  <Trade trade-day="2009-09-21" />
</CDSREQ>
  
```

Example 46 Request for retrieval of evaluations per hours for specific day

RESPONSE.952

In case of successful or failed request processing, response is returned in accordance with specification of [RESPONSE](#) structure, where message-code=952 can be found in the header.

```

<RESPONSE id="7cdd21c0-e21f-4e70-a617-2d55db510e8" message-code="952"
  date-time="2009-07-03T14:16:54Z" dtd-version="1" dtd-release="1"
  xmlns="http://sfera.sk/ws/xmtrade/isot/interfaces/ut/types/2009/04/01">
  <SenderIdentification id="24X-OT-SK-----V" coding-scheme="15"/>
  <ReceiverIdentification id="24XDSO-----Q" coding-scheme="15"/>
  <Reference id="45t"/>
  <Reason code="0" type="A03"/>
</RESPONSE>
  
```

Example 47 Response on success of evaluations retrieval per hours for a specific day

ISOTEDATA.953

In the event of successful request processing, the structure of trading results is returned as it was registered in the system, where message-code=953 can be found in the header.

The following result types are used in *ProfileData/@profile-role* attribute:

- SP02 – clearing/payment for purchased electricity,
- SC02 – amount of purchased electricity,
- SP03 – clearing/payment for sold electricity,
- SC03 – amount of sold electricity,
- SP05 – fee for traded electricity,
- SC05 – amount of traded electricity (the sum of sold and purchased electricity),
- SP90 – fee for trading transactions relating to data manipulation,
- SC90 – amount of trading transactions relating to data manipulation,
- SP91 – fee for trading transactions relating to use of automated interfaces,
- SC91 – amount of trading transactions relating to use of automated interfaces,
- SP92 – clearing/payment for purchased electricity for negative prices (positive number),
- SC92 – quantity of purchased electricity for negative prices (positive number),
- SP93 – clearing/payment for sold electricity for negative prices (positive number),
- SC93 – quantity of sold electricity for negative prices (positive number).

```

<ISOTEDATA id="9d1bd4cd-5c92-4f51-adde-6253a08cfbb" message-code="953"
  date-time="2009-07-03T14:16:54Z" dtd-version="1" dtd-release="1" answer-
  required="false"
  xmlns="http://sfera.sk/ws/xmtrade/isot/interfaces/evaluations/types/2009/04/01">
  <SenderIdentification id="24X-OT-SK-----V" coding-scheme="15"/>
  <ReceiverIdentification id="24XDSO-----Q" coding-scheme="15"/>
  <Reference id="45t"/>
  <Trade trade-day="2009-09-21">
    <ProfileData profile-role="SP02">
      <Data period="1" value="1022.5" unit="EUR"/>
      <Data period="2" value="746.35" unit="EUR"/>
      <Data period="3" value="1300" unit="EUR"/>
      <Data period="4" value="900" unit="EUR"/>
      <Data period="5" value="272.79" unit="EUR"/>
      <Data period="6" value="1621.75" unit="EUR"/>
      <Data period="7" value="2386.3" unit="EUR"/>
      <Data period="8" value="2546.7" unit="EUR"/>
      <Data period="9" value="794.25" unit="EUR"/>
      <Data period="10" value="1019.67" unit="EUR"/>
    </ProfileData>
    <ProfileData profile-role="SC02">
      <Data period="1" value="50" unit="MWH"/>
      <Data period="2" value="23" unit="MWH"/>
      <Data period="3" value="65" unit="MWH"/>
      <Data period="4" value="45" unit="MWH"/>
      <Data period="5" value="12.6" unit="MWH"/>
      <Data period="6" value="65" unit="MWH"/>
      <Data period="7" value="98" unit="MWH"/>
      <Data period="8" value="78" unit="MWH"/>
      <Data period="9" value="45" unit="MWH"/>
      <Data period="10" value="41" unit="MWH"/>
    </ProfileData>
    <ProfileData profile-role="SP03">
      <Data period="1" value="0" unit="EUR"/>
      <Data period="2" value="2086.535" unit="EUR"/>
      <Data period="3" value="0" unit="EUR"/>
      <Data period="4" value="0" unit="EUR"/>
      <Data period="5" value="0" unit="EUR"/>
      <Data period="6" value="583.83" unit="EUR"/>
      <Data period="7" value="1921.215" unit="EUR"/>
      <Data period="8" value="0" unit="EUR"/>
      <Data period="9" value="0" unit="EUR"/>
      <Data period="10" value="748.587" unit="EUR"/>
    </ProfileData>
    <ProfileData profile-role="SC03">
      <Data period="1" value="0" unit="MWH"/>
      <Data period="2" value="64.3" unit="MWH"/>
      <Data period="3" value="0" unit="MWH"/>
      <Data period="4" value="0" unit="MWH"/>
      <Data period="5" value="0" unit="MWH"/>
      <Data period="6" value="23.4" unit="MWH"/>
      <Data period="7" value="78.9" unit="MWH"/>
      <Data period="8" value="0" unit="MWH"/>
      <Data period="9" value="0" unit="MWH"/>
      <Data period="10" value="30.1" unit="MWH"/>
    </ProfileData>
    <Party id="24XDSO-----Q" role="TO"/>
    <ResultStatus status="F"/>
  </Trade>
</ISOTEDATA>

```

Example 48 Response containing request evaluations per hours

4.6.4 Notification of evaluation for a day (E-05_02)

Notification of evaluations for day is carried out by sending a request in *CDSREQ.961* structure (message-code=961) and response with data in *RESPONSE.962* and *ISOTEDATA.963* structure.

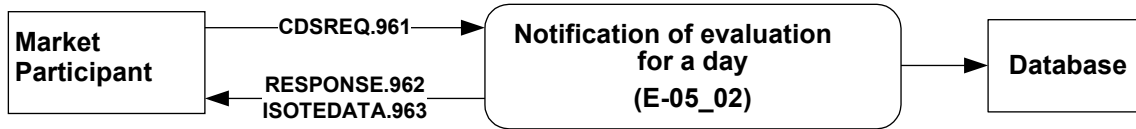

Figure 35 Notification schema of evaluations for day for market participant

CDSREQ.961

Request is formulated for specific trading day (trade-day) and is filled out according to the specification of [CDSREQ](#) structure.

```

<CDSREQ id="45t" message-code="961" date-time="2014-09-19T01:18:33"
  dtd-version="1" dtd-release="1"
  xmlns="http://sfera.sk/ws/xmtrade/isot/interfaces/ut/types/2009/04/01">
  <SenderIdentification id="24XDSO-----Q" coding-scheme="15"/>
  <ReceiverIdentification id="24X-OT-SK-----V" coding-scheme="15"/>
  <Trade trade-day="2009-09-21"/>
</CDSREQ>
  
```

Example 49 Request for retrieval of evaluations cumulatively for trading day

RESPONSE.962

In case of successful or failed request processing, response is returned according to specification of [RESPONSE](#) structure, where message-code=962 can be found in the header.

```

<RESPONSE id="8a848bad-46c2-4e3d-ab78-2c7c4545a21" message-code="962"
  date-time="2009-07-03T14:20:40Z" dtd-version="1" dtd-release="1"
  xmlns="http://sfera.sk/ws/xmtrade/isot/interfaces/ut/types/2009/04/01">
  <SenderIdentification id="24X-OT-SK-----V" coding-scheme="15"/>
  <ReceiverIdentification id="24XDSO-----Q" coding-scheme="15"/>
  <Reference id="45t"/>
  <Reason code="0" type="A03"/>
</RESPONSE>
  
```

Example 50 Response on success of evaluations retrieval cumulatively for trading day

ISOTEDATA.963

In case of successful request processing, the structure of trading results is returned as it was registered in the system, where message-code=963 can be found in the header.

The following result types are used in *ProfileData* /@profile-role attribute:

- SP02 – clearing/payment for purchased electricity,
- SC02 – amount of purchased electricity,
- SP03 – clearing/payment for sold electricity,
- SC03 – amount of sold electricity,
- SP05 – fee for traded electricity,
- SC05 – amount of traded electricity (the sum of sold and purchased electricity),
- ST16 – monthly fee for access on day-ahead market; the last day of month is specified,
- SP90 – fee for trading transactions relating to data manipulation,
- SC90 – amount of trading transactions relating to data manipulation,
- SP91 – fee for trading transactions relating to use of automated interfaces,
- SC91 – amount of trading transactions relating to use of automated interfaces,
- SP92 – clearing/payment for purchased electricity for negative prices (positive number),
- SC92 – quantity of purchased electricity for negative prices (positive number),
- SP93 – clearing/payment for sold electricity for negative prices (positive number),
- SC93 – quantity of sold electricity for negative prices (positive number).

```

<ISOTEDATA id="526539ee-9bb7-465b-8e5c-0b660674f0f" message-code="963"
  date-time="2009-07-03T14:20:40Z" dtd-version="1" dtd-release="1" answer-
  required="false"
  xmlns="http://sfera.sk/ws/xmtrade/isot/interfaces/evaluations/types/2009/04/01">
  <SenderIdentification id="24X-OT-SK-----V" coding-scheme="15" />
  <ReceiverIdentification id="24XDSO-----Q" coding-scheme="15"/>
  <Reference id="45t"/>
  <Trade trade-day="2009-09-21">
    <ProfileData profile-role="SP02">
      <Data period="0" value="27875.987" unit="EUR"/>
    </ProfileData>
    <ProfileData profile-role="SC02">
      <Data period="0" value="1146.7" unit="MWH"/>
    </ProfileData>
    <ProfileData profile-role="SP03">
      <Data period="0" value="17278.838" unit="EUR"/>
    </ProfileData>
    <ProfileData profile-role="SC03">
      <Data period="0" value="639.3" unit="MWH"/>
    </ProfileData>
    <Party id="24XDSO-----Q" role="TO"/>
    <ResultStatus status="F"/>
  </Trade>
</ISOTEDATA>

```

Example 51 Response containing requested results cumulatively for trading day

4.7 Evaluation of IDM

Evaluations of intraday market are available for market participants via operations evaluation for a day or for a whole month retrieval.

4.7.1 Processing level

Results of intraday market are available anytime during a day. Summary results for a day or a month are completed when all periods are closed. Information about traded amount, invoices and debts of market organizer to market participant (debts with minus sign) are in summary result.

4.7.2 Notice of an evaluation for a day (E-07_01)

Notice of an evaluation for a day is carried out by request CDSREQ-VDT.961 structure (message-code=961) and by a response RESPONSE-VDT.962 structure and ISOTEDATA-VDT.963 structure with data.

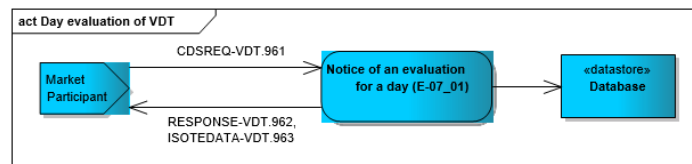

Figure 36 Notice of an evaluation for a day scheme

CDSREQ-VDT.961

The structure contains message-code=961 attribute in the header and is filled out in accordance with [CDSREQ-VDT.961](#) structure. Request is formulated for a specific trade day.

```

<CDSREQ id="45t" message-code="961" date-time="2016-09-19T01:18:33"
  dtd-version="1" dtd-release="1"
  xmlns="http://sfera.sk/ws/xmtrade/isot/interfaces/ut/types/2016/04/01">
  <SenderIdentification id="24X--YOUR-EIC--B" coding-scheme="15"/>
  <ReceiverIdentification id="24X-OT-SK-----V" coding-scheme="15"/>
  <Trade trade-day="2016-09-21" />
</CDSREQ>

```

Example 52 Request for a summary evaluation of a day

RESPONSE-VDT.962

In accordance with specification of [RESPONSE-VDT](#) structure response is given in case of successful or unsuccessful order processing. In this case message-code=802 can be found in the header.

```
<RESPONSE id="8a848bad-46c2-4e3d-ab78-2c7c4545a21" message-code="962"
  date-time="2016-07-03T14:20:40Z" dtd-version="1" dtd-release="1"
  xmlns="http://sfera.sk/ws/xmtrade/isot/interfaces/ut/types/2016/04/01">
  <SenderIdentification id="24X-OT-SK-----V" coding-scheme="15"/>
  <ReceiverIdentification id="24X--YOUR-EIC--B " coding-scheme="15"/>
  <Reference id="45t"/>
  <Reason code="0" type="A03"/>
</RESPONSE>
```

Example 53 Response about successful retrieval of day evaluation

ISOTEDATA-VDT.963

In case of successful order processing, the trading results structure is returned with a message-code=963 in the header.

In attribute ProfileData/@profile-role following results can be found:

- SP08 – reckoning/payment for purchased electricity for a positive price,
- SC08 – amount of purchased electricity for a positive price,
- SP58 – reckoning/payment for purchased electricity for a negative price,
- SC58 – amount of purchased electricity for a negative price,
- SP09 – reckoning/payment for a sold electricity for a positive price,
- SC09 – amount of sold electricity for a positive price,
- SP59 – reckoning/payment for a sold electricity for a negative price,
- SC59 – amount of a sold electricity for a negative price.

```
<ISOTEDATA id="526539ee-9bb7-465b-8e5c-0b660674f0f" message-code="963"
  date-time="2016-07-03T14:20:40Z" dtd-version="1" dtd-release="1" answer-
  required="false"
  xmlns="http://sfera.sk/ws/xmtrade/isot/interfaces/evaluations/types/2016/04/01">
  <SenderIdentification id="24X-OT-SK-----V" coding-scheme="15" />
  <ReceiverIdentification id="24X--YOUR-EIC--B " coding-scheme="15"/>
  <Reference id="45t"/>
  <Trade trade-day="2009-09-21">
    <ProfileData profile-role="SP08">
      <Data value="27875.987" unit="EUR"/>
    </ProfileData>
    <ProfileData profile-role="SC08">
      <Data value="1146.7" unit="MWH"/>
    </ProfileData>
    <ProfileData profile-role="SP09">
      <Data value="17278.838" unit="EUR"/>
    </ProfileData>
    <ProfileData profile-role="SC09">
      <Data value="639.3" unit="MWH"/>
    </ProfileData>
    <Party id="24X--YOUR-EIC--B " role="TO"/>
  </Trade>
```

Example 54 Response with day evaluation results

4.7.3 Notice of an evaluation for a month (E-07_02)

Notice of an evaluation for a month is carried out by request CDSREQ-VDT.571 structure (message-code=571) and by a response RESPONSE-VDT.572 structure and ISOTEDATA-VDT.573 structure with data.

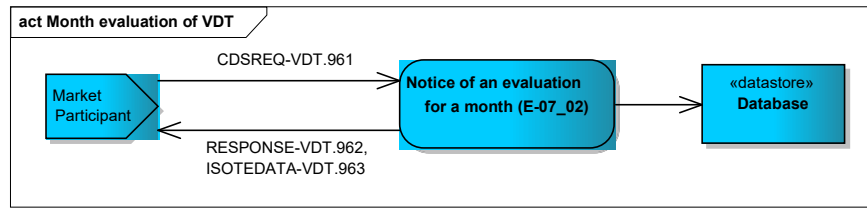

Figure 37 Notice of an evaluation for a month scheme

CDSREQ-VDT.571

The structure contains message-code=571 attribute in the header and is filled out in accordance with [CDSREQ-VDT](#) structure. Request is formulated for a concrete trade month.

```

<CDSREQ id="45t" message-code="571" date-time="2016-09-19T01:18:33"
  dtd-version="1" dtd-release="1"
  xmlns="http://sfera.sk/ws/xmtrade/isot/interfaces/ut/types/2016/04/01">
  <SenderIdentification id="24X--YOUR-EIC--B " coding-scheme="15"/>
  <ReceiverIdentification id="24X-OT-SK-----V" coding-scheme="15"/>
  <Trade trade-month="2016-09" />
</CDSREQ>
  
```

Example 55 Request for a summary evaluation of a month

RESPONSE-VDT.572

According to specification of [RESPONSE-VDT](#) structure response is given in case of successful or unsuccessful order processing. In this case message-code=572 can be found in the header.

```

<RESPONSE id="8a848bad-46c2-4e3d-ab78-2c7c4545a21" message-code="572"
  date-time="2016-07-03T14:20:40Z" dtd-version="1" dtd-release="1"
  xmlns="http://sfera.sk/ws/xmtrade/isot/interfaces/ut/types/2016/04/01">
  <SenderIdentification id="24X-OT-SK-----V" coding-scheme="15"/>
  <ReceiverIdentification id="24X--YOUR-EIC--B " coding-scheme="15"/>
  <Reference id="45t"/>
  <Reason code="0" type="A03"/>
</RESPONSE>
  
```

Example 56 Response about successful retrieval of month evaluation

ISOTEDATA-VDT.573

In case of successful order processing, the trading results structure is returned with a message-code=573 in the header.

In attribute ProfileData/@profile-role following results can be found:

- SP08 – reckoning/payment for purchased electricity for a positive price,
- SC08 – amount of purchased electricity for a positive price,
- SP58 – reckoning/payment for purchased electricity for a negative price,
- SC58 – amount of purchased electricity for a negative price,
- SP09 – reckoning/payment for a sold electricity for a positive price,
- SC09 – amount of sold electricity for a positive price,
- SP59 – reckoning/payment for a sold electricity for a negative price,
- SC59 – amount of a sold electricity for a negative price,
- SP10 – charge for traded electricity,
- SC10 – amount of traded electricity (price of sold and purchased).

```

<ISOTEDATA id="526539ee-9bb7-465b-8e5c-0b660674f0f" message-code="573"
  date-time="2016-07-03T14:20:40Z" dtd-version="1" dtd-release="1" answer-
  required="false"
  xmlns="http://sfera.sk/ws/xmtrade/isot/interfaces/evaluations/types/2016/04/01">
  <SenderIdentification id="24X-OT-SK-----V" coding-scheme="15" />
  <ReceiverIdentification id="24X--YOUR-EIC--B " coding-scheme="15"/>
  <Reference id="45t"/>
  <Trade trade-month="2016-09">
    <ProfileData profile-role="SP08">
      <Data value="27875.987" unit="EUR"/>
    </ProfileData>
    <ProfileData profile-role="SC08">
      <Data value="1146.7" unit="MWH"/>
    </ProfileData>
    <ProfileData profile-role="SP09">
      <Data value="17278.838" unit="EUR"/>
    </ProfileData>
    <ProfileData profile-role="SC09">
      <Data value="639.3" unit="MWH"/>
    </ProfileData>
    <ProfileData profile-role="SP10">
      <Data value="727.8" unit="EUR"/>
    </ProfileData>
    <ProfileData profile-role="SP10">
      <Data value="88839.3" unit="MWH"/>
    </ProfileData>
    <Party id="24X--YOUR-EIC--B " role="TO"/>
  </Trade>

```

Example 57 Response with month evaluation results

4.7.4 Notice of evaluation for time periods (E-07_03)

Notice of an evaluation for time periods is carried out by request CDSREQ-VDT.951 structure (message-code=951) and by a response RESPONSE-VDT.952 structure and ISOTEDATA-VDT.953 structure with data.

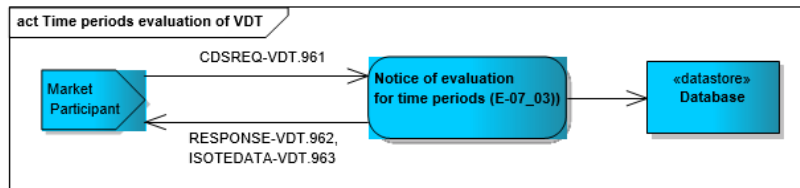

Figure 38 Notice of an evaluation for time periods scheme

CDSREQ-VDT.951

The structure contains message-code=951 attribute in the header and is filled out in accordance with [CDSREQ-VDT](#) structure. Request is formulated for a concrete trade day or a concrete day can be specified with period-from, period-to.

```

<CDSREQ date-time="2017-04-11T07:00:00" dtd-release="1" dtd-version="1" id="45t" message-
  code="951" xmlns="http://sfera.sk/ws/xmtrade/isot/interfaces/ut/types/2009/04/01">
  <SenderIdentification coding-scheme="15" id="24X--YOUR-EIC--B"/>
  <ReceiverIdentification coding-scheme="15" id="24X-OT-SK-----V"/>
  <Trade trade-day="2017-02-12"/>
</CDSREQ>

```

Example 58 Request for an evaluation of time periods for whole day

```

<CDSREQ date-time="2017-04-11T07:00:00" dtd-release="1" dtd-version="1" id="45t" message-
  code="951" xmlns="http://sfera.sk/ws/xmtrade/isot/interfaces/ut/types/2009/04/01">
  <SenderIdentification coding-scheme="15" id="24X--YOUR-EIC--B"/>
  <ReceiverIdentification coding-scheme="15" id="24X-OT-SK-----V"/>
  <Trade trade-day="2017-02-12" period-from="8" period-to="20" delivery-duration="60"/>
</CDSREQ>

```

Example 59 Request for an evaluation of time periods for specific period

RESPONSE-VDT.952

In accordance with [RESPONSE-VDT](#) structure response is given in case of successful or unsuccessful order processing. In this case message-code=952 can be found in the header.

```
<RESPONSE id="8a848bad-46c2-4e3d-ab78-2c7c4545a21" message-code="952"
  date-time="2016-07-03T14:20:40Z" dtd-version="1" dtd-release="1"
  xmlns="http://sfera.sk/ws/xmtrade/isot/interfaces/ut/types/2016/04/01">
  <SenderIdentification id="24X-OT-SK-----V" coding-scheme="15"/>
  <ReceiverIdentification id="24X--YOUR-EIC--B " coding-scheme="15"/>
  <Reference id="45t"/>
  <Reason code="0" type="A03"/>
</RESPONSE>
```

Example 60 Response about successful retrieval of time periods evaluation

ISOTEDATA-VDT.953

In case of successful order processing, the trading results structure is returned with a message-code=953 in the header. In attributes Trade/ProfileData/Data/@period-from and Trade/ProfileData/Data/@period-to can be found specified interval of delivery. These intervals represent order of time periods in a specific day.

In attribute ProfileData/@profile-role following results can be found:

- SP08 – reckoning/payment for purchased electricity for a positive price,
- SC08 – amount of purchased electricity for a positive price,
- SP58 – reckoning/payment for purchased electricity for a negative price,
- SC58 – amount of purchased electricity for a negative price,
- SP09 – reckoning/payment for a sold electricity for a positive price,
- SC09 – amount of sold electricity for a positive price,
- SP59 – reckoning/payment for a sold electricity for a negative price,
- SC59 – amount of a sold electricity for a negative price.

```

<ISOTEDATA id="917de340469d45ab9cc14ec18797c31f" message-code="963" date-time="2017-04-
11T12:17:50Z" dtd-version="1" dtd-release="1" answer-required="false"
xmlns="http://sfera.sk/xmtrade/isot/types/IDM/2016/04">
  <SenderIdentification id="24X-OT-SK-----V" coding-scheme="15"/>
  <ReceiverIdentification id="24X--YOUR-EIC--B " coding-scheme="15"/>
  <Reference id="45t"/>
  <Trade trade-day="2017-02-12" delivery-duration="60">
    <ProfileData profile-role="SP08">
      <Data period-from="0" period-to="1" value="10.0" unit="EUR"/>
    </ProfileData>
    <ProfileData profile-role="SC08">
      <Data period-from="0" period-to="1" value="1.0" unit="MWH"/>
    </ProfileData>
    <ProfileData profile-role="SP58">
      <Data period-from="0" period-to="1" value="0.0" unit="EUR"/>
    </ProfileData>
    <ProfileData profile-role="SC58">
      <Data period-from="0" period-to="1" value="0.0" unit="MWH"/>
    </ProfileData>
    <ProfileData profile-role="SP09">
      <Data period-from="0" period-to="1" value="50.0" unit="EUR"/>
    </ProfileData>
    <ProfileData profile-role="SC09">
      <Data period-from="0" period-to="1" value="2.0" unit="MWH"/>
    </ProfileData>
    <ProfileData profile-role="SP59">
      <Data period-from="0" period-to="1" value="0.0" unit="EUR"/>
    </ProfileData>
    <ProfileData profile-role="SC59">
      <Data period-from="0" period-to="1" value="0.0" unit="MWH"/>
    </ProfileData>
    <ProfileData profile-role="SP08">
      <Data period-from="1" period-to="2" value="10.0" unit="EUR"/>
    </ProfileData>
    <ProfileData profile-role="SC08">
      <Data period-from="1" period-to="2" value="0.5" unit="MWH"/>
    </ProfileData>
    <ProfileData profile-role="SP58">
      <Data period-from="1" period-to="2" value="0.0" unit="EUR"/>
    </ProfileData>
    <ProfileData profile-role="SC58">
      <Data period-from="1" period-to="2" value="0.0" unit="MWH"/>
    </ProfileData>
    <ProfileData profile-role="SP09">
      <Data period-from="1" period-to="2" value="100.0" unit="EUR"/>
    </ProfileData>
    <ProfileData profile-role="SC09">
      <Data period-from="1" period-to="2" value="5.0" unit="MWH"/>
    </ProfileData>
    <ProfileData profile-role="SP59">
      <Data period-from="1" period-to="2" value="0.0" unit="EUR"/>
    </ProfileData>
    <ProfileData profile-role="SC59">
      <Data period-from="1" period-to="2" value="0.0" unit="MWH"/>
    </ProfileData>
    <Party id="24X--YOUR-EIC--B " role="TO"/>
  </Trade>
</ISOTEDATA>

```

Example 61 Response with time periods evaluation results (2 periods)

4.8 AMQP notifications

Notification via AMQP protocol automatically informs market participants about changes in their own orders, or changes in the order book.

4.8.1 Processing level

The market participant connected to AMQP interface has the opportunity to get automatic notifications. Queues are automatically created, and allows users to get notification about following event:

- Successfully created order – dataflow (E-10_01),
- Change of the order (status change) – dataflow E-10_01,
- Change in the order book (change of available amount and last price/quantity for periods where the change occurred) – dataflow E-10_02.

4.8.2 Status change/Creation of own order (E-10_01)

Notification via AMQP protocol is send within dataflow and inform market participant about status changes of own order or about creation of new own order. Notification is sent automatically in accordance with ISOTEDATA-VDT.820 structure (message-code=820).

Notification is a reaction on change, which was called by:

- Market participant (creation or modification of an order),
- Another market participant (whole order traded or part of the order traded),
- System (expiration of the order, or more precisely time period in which was the order inputted and changed afterwards).

Following pictures show transmission of messages which are send when the order is created by market participant connected to AMQP interface via web services. Notification about created order is send to market participant connected to AMQP interface even in case when another subject create order for the market participant via web page XMtrade®/ISOT.

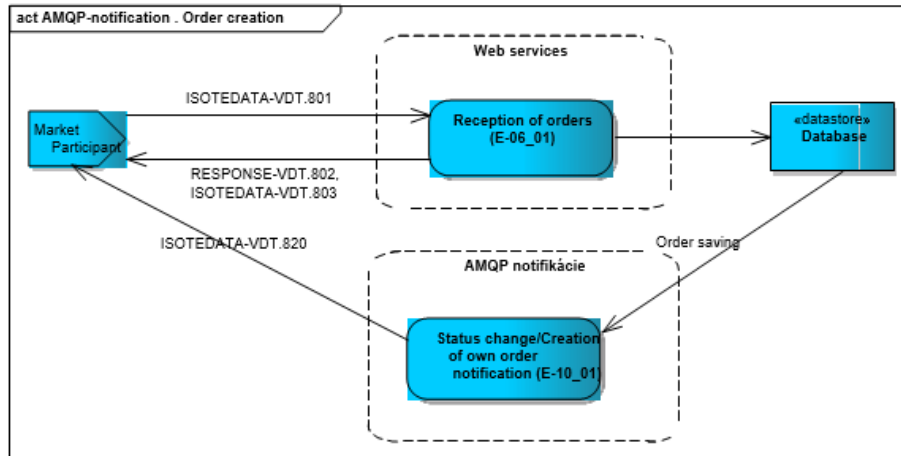

Figure 39 Sending messages scheme – order creation (AMQP notification)

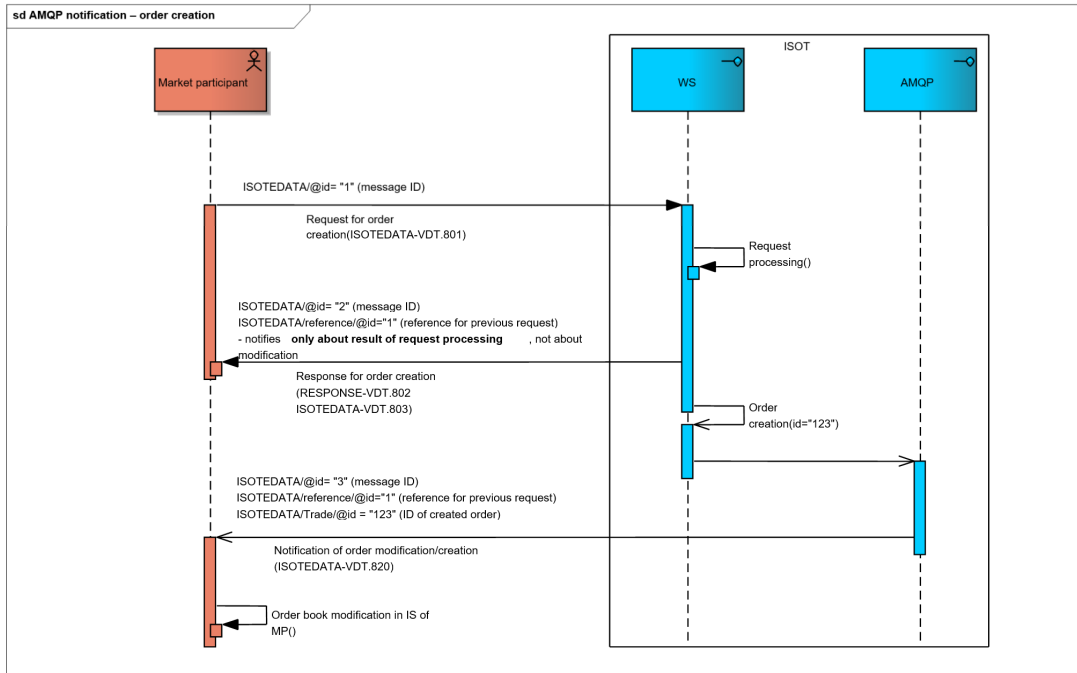

Figure 40 Order of sent messages scheme – order creation (AMQP notification)

Following pictures show transmission of messages which are sent when the order is modified by market participant connected to AMQP interface via web services. Notification about modified order is send to market participant connected to AMQP interface even in case when another subject modified order for the market participant via web page XMtrade®/ISOT.

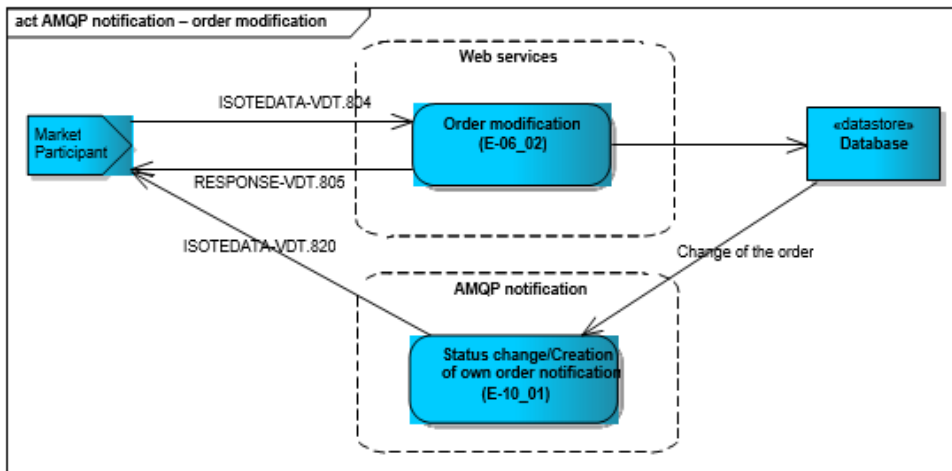

Figure 41 Sending messages scheme – order modification (AMQP notification)

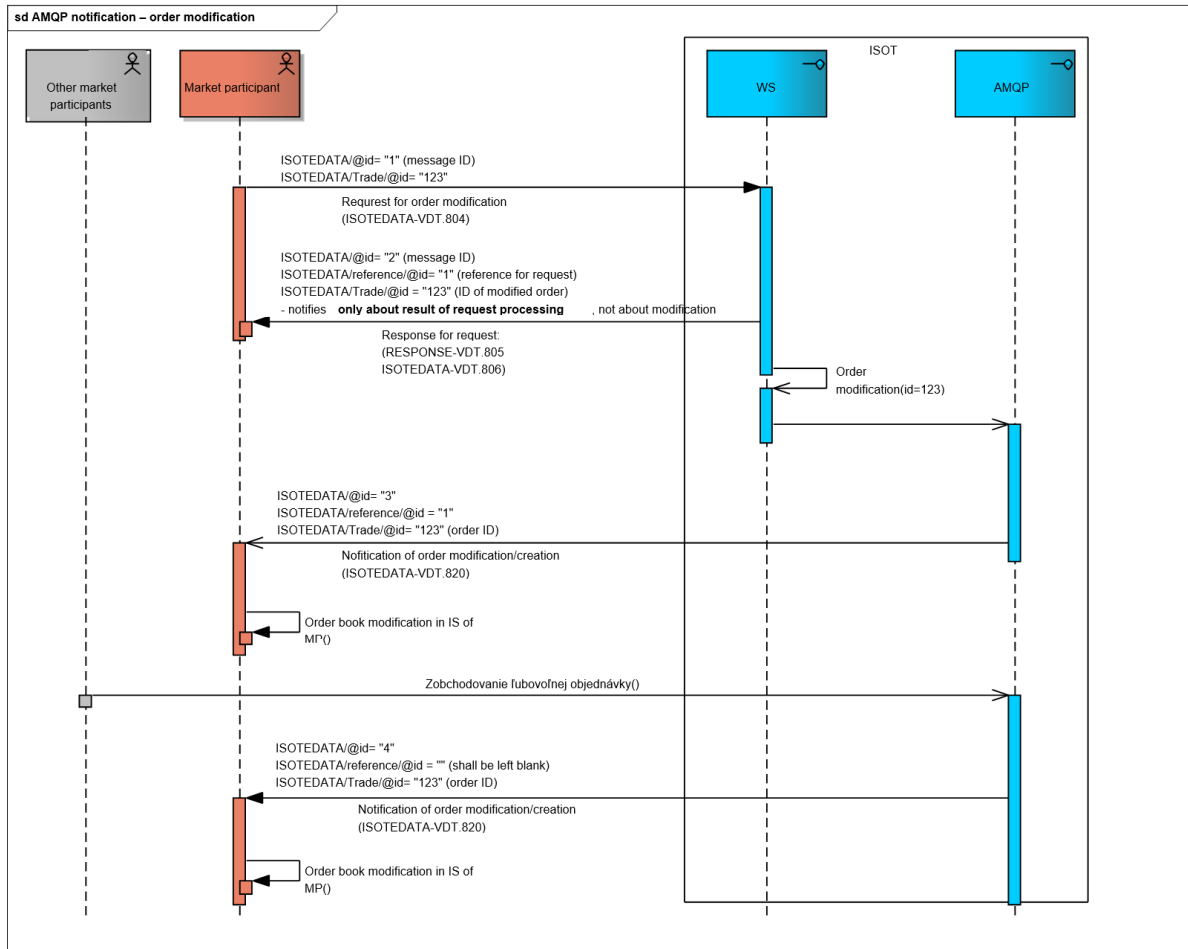

Figure 42 Order of sent messages scheme – order modification (AMQP notification)

ISOTEDATA-VDT.820

In the case of events shown above, the structure of the order data is sent through the AMQP protocol, with a message-code=820 in the header.

In attribute Reference/@id is reference to a message, which called out order creation. ID of created order is returned in attribute Trade/@id, which can be saved or paired in market participant order system via web service.

```

<ISOTEDATA id="ac5e799q-2qtr-75e7-9bef-8aabc02b7f4" message-code="820" date-time="2016-02-15T16:30:10Z" dtd-version="1" dtd-release="1" answer-required="false" xmlns="http://sfera.sk/xmtrade/isot/types/IDM/2016/04">
  <SenderIdentification id="24X-OT-SK-----V" coding-scheme="15"/>
  <ReceiverIdentification id="24X--YOUR-EIC--B" coding-scheme="15" />
  <!--reference to message 801 - request for order submission-->
  <Reference id="1"/>
  <Trade id="1016" trade-day="2016-02-16" order-expiration="2016-02-15T19:30:10" trade-type="N" block-order="N" indication="N" trade-stage="P" trader-id="123456" delivery-duration="60" market-area="SK" sett-curr="EUR" market="VDT">
    <TimeData datetime="2016-02-15T16:30:10Z" datetime-type="DTC"/>
    <ProfileData profile-role="BC01">
      <Data period-from="0" period-to="1" value="10.1" unit="MW" />
    </ProfileData>
    <ProfileData profile-role="BP01">
      <Data period-from="0" period-to="1" value="40.00" unit="EUR" />
    </ProfileData>
    <Party id="24X--YOUR-EIC--B" role="TO"/>
  </Trade>
</ISOTEDATA>
    
```

Example 62 Example of change in market participant order notification

4.8.3 Change of the order book data (E-10_02)

Notification via AMQP protocol is sent within dataflow and inform market participant about order book status changes. Notification is sent automatically in accordance with ISOTEDATA-VDT.830 structure (message-code=830). Same message is sent to all users connected to AMQP interface, but corresponding notification is not at the same level as the header addressed to a specific market participant (element ReceiverIdentification is not used).

Notification is a reaction to change in the order book, which can be caused by following cases that have consequences to amounts in one or more trading time periods:

- Market participant (adding, trading, modification of an order),
- Change caused by other market participant (adding, trading, modification of an order),
- System (expiration of an order, more precisely time period which can cause annullment of available amount in concrete time period).

Following pictures show messages transmission and sequence of those messages, which are sent to gather actual status of the order book. These messages are sent in case market participant is connected to AMQP interface and do not gather overall data from the order book via web services.

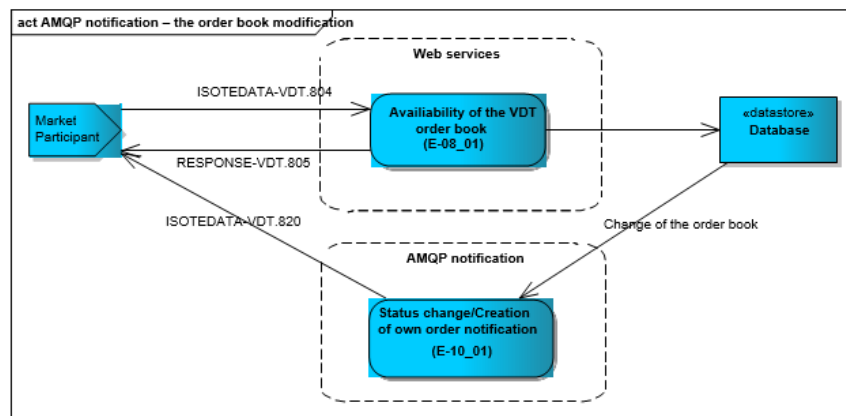

Figure 43 Sent messages scheme – order creation (AMQP notification)

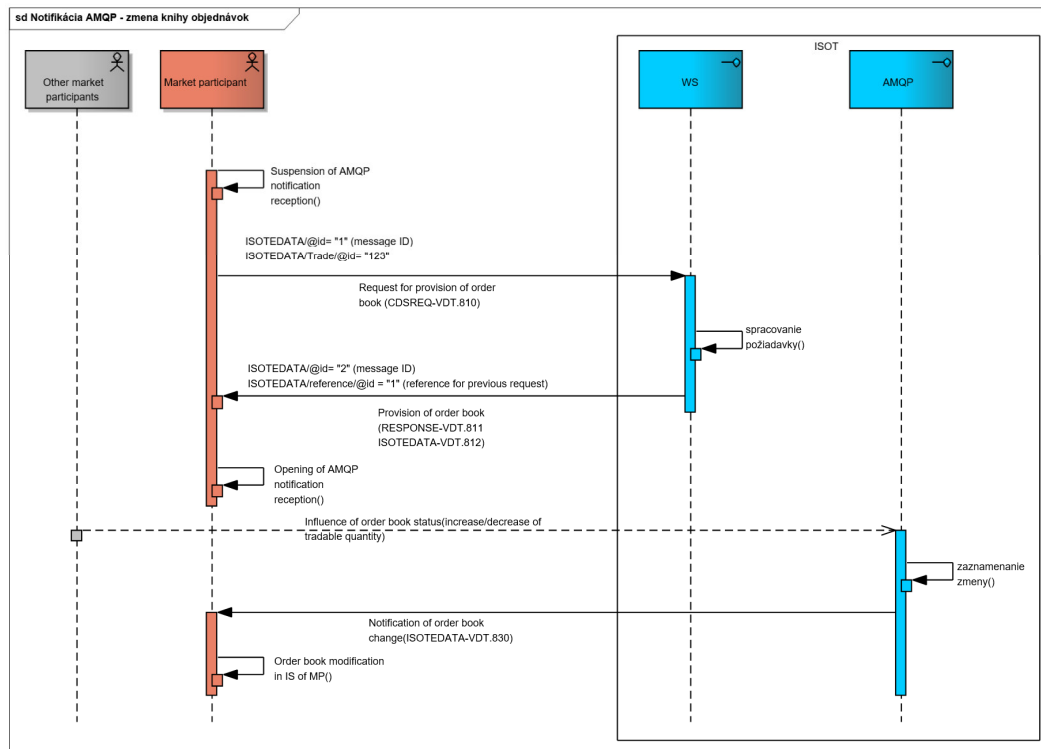

Figure 44 Sequentiality of sent messages scheme – modification of order book (AMQP notification)

Method of gathering and keeping up-to-date status of the order book is following:

1. Connect to AMQP interface
2. Intermit queue processing for income of automatized notifications.
3. Download the data of the order book via web services.
 - a. During downloading data of the order book via web services it is necessary for market participant to not receive notification about changes in the order book.
4. Start receiving notification about changes in the order book
 - a. This step ensures actualization of the order book – changes which were made during the downloading the order book via web services will be included
 - b. The market participant will be informed about following changes automatically
5. In case market participant needs to download the order book again via web services, it is necessary to start with step number 2.
6. More information about connection failure can be found in the chapter [Communication security 3.2.3](#).

Information necessary for correct notification processing and keeping up-to-date order book:

- Every notification regarded to the order book change, rewrite original amount of the order book for the specific type of order, direction(purchase/sale) and limited price.
- Every change represents one notification in a single XML document.
- In case of block order change, (base-load, peak-load and off-peak) notifications are always sent for side of orders and at the same time for side of sale. In case of change in user-defined block order, notifications about change are sent for all own orders in specific trading time periods.

ISOTEDATA-VDT.830

In case of events shown above, structure of the order book is sent through the AMQP protocol, with a message-code=830 in the header.

This type of message is not intended for a specific user, or market participant, but is intended for all users connected to AMQP interface. Element ReceiverIdentification is not filled out in the message. Amount for a specific price in specific time periods is shown in the message.

Following examples show sending of notification principle:

Example 1

1. Period 12-13 has the following amounts on trading day 7/13/2016:

Trading day: 13.7.2016	Purchase		Sale	
	Amount [MWh]	Price [EUR/MW]	Amount [MWh]	Price [EUR/MW]
Period:12-13	10,0	31,00		

2. Simple order for purchase (without indications) is booked for this period with amount of 11MW for 31 EUR/MW.
3. Period 12-13 will contain following amounts after matching:

Trading day: 13.7.2016	Purchase		Sale	
	Amount [MWh]	Price [EUR/MW]	Amount [MWh]	Price [EUR/MW]
Period:12-13	0,0	31,00	1,0	31,00

4. Notification no.1, showed below, represents change in amount at the side of purchase at 12-13 period to 0 MW for price 31 EUR/MW. Notification no.2 represents raise of amount at the side of sale to 1 MW for price 31 EURPMW. Both notifications include information of last price/quantity and overall traded quantity of the period 12-13 within sections TC01, LC01, LP01.

```

<!--notification no.1-->
<?xml version="1.0" encoding="utf-8"?>
<ISOTEDATA xmlns:xsd="http://www.w3.org/2001/XMLSchema"
xmlns:xsi="http://www.w3.org/2001/XMLSchema-instance" id="56f4aab9fd36497497b38fd0ef3a0223"
message-code="830" date-time="2017-08-07T11:04:02Z" dtd-version="1" dtd-release="1" answer-
required="false" xmlns="http://sfera.sk/xmtrade/isot/types/IDM/2016/04">
  <SenderIdentification id="24X-OT-SK-----V" coding-scheme="15" />
  <!--den D, posledná cena/množstvo-->
  <Trade trade-day="2016-07-13" delivery-duration="60" market-area="SK" sett-curr="EUR"
market="VDT">
    <TimeData datetime="2016-07-13T11:04:02.123Z" datetime-type="DTO"/>
    <ProfileData profile-role="TC01">
      <Data period-from="12" period-to="13" value="20.0" unit="MW"/>
    </ProfileData>
    <ProfileData profile-role="LC01">
      <Data period-from="12" period-to="13" value="10.0" unit="MW"/>
    </ProfileData>
    <ProfileData profile-role="LP01">
      <Data period-from="12" period-to="13" value="31.00" unit="EUR" price-
direction="N"/>
    </ProfileData>
  </Trade>
  <Trade trade-day="2017-07-13" trade-type="N" block-order="N" delivery-duration="60"
market="VDT" sett-curr="EUR" market-area="SK">
    <TimeData datetime="2017-07-13T11:04:02.808951Z" datetime-type="DTO" />
    <ProfileData profile-role="BP01">
      <Data period-from="12" period-to="13" value="31" unit="EUR" />
    </ProfileData>
    <ProfileData profile-role="BC01">
      <Data period-from="12" period-to="13" value="0" unit="MW" />
    </ProfileData>
  </Trade>
</ISOTEDATA>

<!--notification no.2-->
<?xml version="1.0" encoding="utf-8"?>
<ISOTEDATA xmlns:xsd="http://www.w3.org/2001/XMLSchema"
xmlns:xsi="http://www.w3.org/2001/XMLSchema-instance" id="56f4aab9fd36497497b38fd0ef3a0223"
message-code="830" date-time="2017-08-07T11:04:02Z" dtd-version="1" dtd-release="1" answer-
required="false" xmlns="http://sfera.sk/xmtrade/isot/types/IDM/2016/04">
  <SenderIdentification id="24X-OT-SK-----V" coding-scheme="15" />
  <Trade trade-day="2016-07-13" delivery-duration="60" market-area="SK" sett-curr="EUR"
market="VDT">
    <TimeData datetime="2016-07-13T11:04:02.123Z" datetime-type="DTO"/>
    <ProfileData profile-role="TC01">
      <Data period-from="12" period-to="13" value="20.0" unit="MW"/>
    </ProfileData>
    <ProfileData profile-role="LC01">
      <Data period-from="12" period-to="13" value="10.0" unit="MW"/>
    </ProfileData>
    <ProfileData profile-role="LP01">
      <Data period-from="12" period-to="13" value="31.00" unit="EUR" price-
direction="N"/>
    </ProfileData>
  </Trade>
  <Trade trade-day="2017-07-13" trade-type="P" block-order="N" delivery-duration="60"
market="VDT" sett-curr="EUR" market-area="SK">
    <TimeData datetime="2017-07-13T11:04:02.808951Z" datetime-type="DTO" />
    <ProfileData profile-role="BP01">
      <Data period-from="12" period-to="13" value="31" unit="EUR" />
    </ProfileData>
    <ProfileData profile-role="BC01">
      <Data period-from="12" period-to="13" value="1" unit="MW" />
    </ProfileData>
  </Trade>
</ISOTEDATA>

```

Example 63 Example notification of change in the order book (change at the of purchase and sale and last price/quantity in the period)

Example 2

1. Period 16-17 has the following amounts on trading day 7/13/2016:

Trading day:	Purchase	Sale
--------------	----------	------

13.7.2016	Amount [MWh]	Price [EUR/MW]	Amount [MWh]	Price [EUR/MW]
Period:16-17			5,0	45,00
			3,0	46,00
			2,0	46,15

2. Simple order for purchase (without indications) is booked for this period with amount of 10MW for 47 EUR/MW.

3. Period 16-17 will contain following amounts after matching:

Trading day: 13.7.2016	Purchase		Sale	
	Amount [MWh]	Price [EUR/MW]	Amount [MWh]	Price [EUR/MW]
Period:16-17			0,0	45,00
			0,0	46,00
			0,0	46,15

4. Notification no.1 represents change in amount at the side of purchase at 16-17 period to 0 MW for price 45 EUR/MW. Notification no.2 represents change to 0 MW for price 46,15 EUR/MW and notification no.3 represents change to 0 MW for price 46 EUR/MW. Both notifications include information of last price/quantity and overall traded quantity of the period 16-17 within sections TC01, LC01, LP01.

```
<!--notifikacia c.1-->
<?xml version="1.0" encoding="utf-8"?>
<ISOTEDATA xmlns:xsd="http://www.w3.org/2001/XMLSchema"
xmlns:xsi="http://www.w3.org/2001/XMLSchema-instance" id="8ddc0826d77847aea837c057865adffd"
message-code="830" date-time="2017-08-07T11:11:26Z" dtd-version="1" dtd-release="1" answer-
required="false" xmlns="http://sfera.sk/xmtrade/isot/types/IDM/2016/04">
  <SenderIdentification id="24X-OT-SK-----V" coding-scheme="15" />
  <Trade trade-day="2016-07-13" delivery-duration="60" market-area="SK" sett-curr="EUR"
market="VDT">
    <TimeData datetime="2016-07-13T11:04:02.123Z" datetime-type="DTO"/>
    <ProfileData profile-role="TC01">
      <Data period-from="16" period-to="17" value="20.0" unit="MW"/>
    </ProfileData>
    <ProfileData profile-role="LC01">
      <Data period-from="16" period-to="17" value="2.0" unit="MW"/>
    </ProfileData>
    <ProfileData profile-role="LP01">
      <Data period-from="16" period-to="17" value="46.15" unit="EUR" price-direction="I"/>
    </ProfileData>
  </Trade>
  <Trade trade-day="2017-07-13" trade-type="P" block-order="N" delivery-duration="60"
market="VDT" sett-curr="EUR" market-area="SK">
    <TimeData datetime="2017-07-13T11:11:26.4356724Z" datetime-type="DTO" />
    <ProfileData profile-role="BP01">
      <Data period-from="16" period-to="17" value="45" unit="EUR" />
    </ProfileData>
    <ProfileData profile-role="BC01">
      <Data period-from="16" period-to="17" value="0" unit="MW" />
    </ProfileData>
  </Trade>
</ISOTEDATA>

<!--notifikacia c.2-->
<?xml version="1.0" encoding="utf-8"?>
<ISOTEDATA xmlns:xsd="http://www.w3.org/2001/XMLSchema"
xmlns:xsi="http://www.w3.org/2001/XMLSchema-instance" id="8ddc0826d77847aea837c057865adffd"
message-code="830" date-time="2017-08-07T11:11:26Z" dtd-version="1" dtd-release="1" answer-
required="false" xmlns="http://sfera.sk/xmtrade/isot/types/IDM/2016/04">
  <SenderIdentification id="24X-OT-SK-----V" coding-scheme="15" />
  <Trade trade-day="2016-07-13" delivery-duration="60" market-area="SK" sett-curr="EUR"
market="VDT">
    <TimeData datetime="2016-07-13T11:04:02.123Z" datetime-type="DTO"/>
    <ProfileData profile-role="TC01">
      <Data period-from="16" period-to="17" value="20.0" unit="MW"/>
    </ProfileData>
    <ProfileData profile-role="LC01">
      <Data period-from="16" period-to="17" value="2.0" unit="MW"/>
    </ProfileData>
    <ProfileData profile-role="LP01">
      <Data period-from="16" period-to="17" value="46.15" unit="EUR" price-direction="I"/>
    </ProfileData>
  </Trade>
  <Trade trade-day="2017-07-13" trade-type="P" block-order="N" delivery-duration="60"
market="VDT" sett-curr="EUR" market-area="SK">
    <TimeData datetime="2017-07-13T11:11:26.4356724Z" datetime-type="DTO" />
    <ProfileData profile-role="BP01">
      <Data period-from="16" period-to="17" value="46.15" unit="EUR" />
    </ProfileData>
    <ProfileData profile-role="BC01">
      <Data period-from="16" period-to="17" value="0" unit="MW" />
    </ProfileData>
  </Trade>
</ISOTEDATA>
```



```

<!--notifikacia c.3-->
<?xml version="1.0" encoding="utf-8"?>
<ISOTEDATA xmlns:xsd="http://www.w3.org/2001/XMLSchema"
xmlns:xsi="http://www.w3.org/2001/XMLSchema-instance" id="8ddc0826d77847aea837c057865adffd"
message-code="830" date-time="2017-08-07T11:11:26Z" dtd-version="1" dtd-release="1" answer-
required="false" xmlns="http://sfera.sk/xmtrade/isot/types/IDM/2016/04">
  <SenderIdentification id="24X-OT-SK-----V" coding-scheme="15" />
  <Trade trade-day="2016-07-13" delivery-duration="60" market-area="SK" sett-curr="EUR"
market="VDT">
    <TimeData datetime="2016-07-13T11:04:02.123Z" datetime-type="DTO"/>
    <ProfileData profile-role="TC01">
      <Data period-from="16" period-to="17" value="20.0" unit="MW"/>
    </ProfileData>
    <ProfileData profile-role="LC01">
      <Data period-from="16" period-to="17" value="2.0" unit="MW"/>
    </ProfileData>
    <ProfileData profile-role="LP01">
      <Data period-from="16" period-to="17" value="46.15" unit="EUR" price-direction="I"/>
    </ProfileData>
  </Trade>
  <Trade trade-day="2017-07-13" trade-type="P" block-order="N" delivery-duration="60"
market="VDT" sett-curr="EUR" market-area="SK">
    <TimeData datetime="2017-07-13T11:11:26.4356724Z" datetime-type="DTO" />
    <ProfileData profile-role="BP01">
      <Data period-from="16" period-to="17" value="46" unit="EUR" />
    </ProfileData>
    <ProfileData profile-role="BC01">
      <Data period-from="16" period-to="17" value="0" unit="MW" />
    </ProfileData>
  </Trade>
</ISOTEDATA>

```

Example 64 Example notification of change in the order book (the side of sale, different prices and last price/quantity in the period)

4.8.4 Change in cross-border capacities data H2H (E-10_03)

Notification informing the market participant about a change in available cross-border capacities (H2H) is sent using AMQP protocol in case of operation of coordinated cross-border intraday market. Notification is generated by the central matching mechanism within the SIDC, while ISOT system is automatically processing this information and forwarding it to market participants connected via AMQP interfaces. Notification is automatically sent in the structure ISOTEDATA-VDT.843 (message-code=843). Form of XML file shares the logic with the message ISOTEDATA-VDT.842 sent as a part of response within the data flow E-08_02. Notification about a change sent within AMQP interfaces includes only those periods which are subject to the change.

Notification is a response to change within the shared order book, which may be caused by change within the order book status within coupled cross-border intraday market with regard to cross-border capacities or by a change within the cross-border capacities values defined by transmission system operators.

ISOTEDATA-VDT.843

In case of occurrence of previously mentioned events, message containing change in available cross-border capacities data with message-code=843 is sent via AMQP protocol.

```

<ISOTEDATA xmlns:xsd="http://www.w3.org/2001/XMLSchema"
xmlns:xsi="http://www.w3.org/2001/XMLSchema-instance" id="d48ee3c16f7e4c24b3a9a3c9ad741ec2"
message-code="843" date-time="2022-09-27T08:41:10Z" dtd-version="1" dtd-release="1" answer-
required="false" xmlns="http://sfera.sk/xmtrade/isot/types/IDM/2016/04">
  <SenderIdentification id="24X-OT-SK-----V" coding-scheme="15" />
  <Trade market="VDT" delivery-duration="60" market-area="SK" area-from="10YSK-SEPS-----K" area-
to="10YCZ-CEPS-----N">
    <TimeData datetime="2022-09-27T08:41:10.1720189Z" datetime-type="DTO" />
    <ProfileData profile-role="AC01">
      <Data period-from="14" period-to="15" value="1923.4" unit="MW" />
    </ProfileData>
    <ProfileData profile-role="AC02">
      <Data period-from="14" period-to="15" value="1425.8" unit="MW" />
    </ProfileData>
  </Trade>
</ISOTEDATA>

```

Example 65 Example of notification about change in available cross-border capacities data (H2H)

4.9 IDA results and evaluations

Results and evaluations of intraday auctions are available for market participants via operations for IDA results and evaluation retrieval for every period or a whole day.

4.9.1 Processing level

Results of intraday auction are available immediately after order matching and contain accepted amount and final marginal price (system or area price). Market participant is notified about results availability via ISOT system.

Evaluations of intraday auction are available immediately after clearing of specific auction in the form of summary daily evaluation as well as detailed evaluation per periods. Evaluations contain market organizer obligations and receivables towards a market participant. (receivables are stated with a negative sign). Market participant is notified about evaluations availability via ISOT system. Results of day-ahead market are made available in ISOT.

Evaluations within the intraday auctions are recalculated to MWh quantity unit according to the usage of 15-minute trading periods.

4.9.2 Notification of results for market participants (E-11_01)

Notification of IDA results for market participants is carried out by request in *CDSREQ.941* structure (message-code=941) and response with data in *RESPONSE.942* and *ISOTEDATA.943* structure.



Figure 45 Notification of IDA results for MP scheme

CDSREQ.941

Request is formulated for specific auction (trade-day and auction-id) and is filled out in accordance with the specification of [CDSREQ](#) structure.

```
<CDSREQ id="45t" message-code="941" date-time="2023-12-01T01:18:33"
  dtd-version="1" dtd-release="1"
  xmlns="http://sfera.sk/ws/xmtrade/isot/interfaces/ut/types/2009/04/01">
  <SenderIdentification id="24XDSO-----Q" coding-scheme="15"/>
  <ReceiverIdentification id="24X-OT-SK-----V" coding-scheme="15"/>
  <Trade trade-day="2023-12-01" auction-id="IDA1"/>
</CDSREQ>
```

Example 66 Request for downloading IDA results for specific auction

RESPONSE.942

In case of successful or failed request processing, response is returned in accordance with specification of [RESPONSE](#) structure, where message-code=942 can be found in the header.

```
<RESPONSE id="bd12362f-361b-4085-ade0-9ed678efff1" message-code="942"
  date-time="2023-12-01T14:11:43Z" dtd-version="1" dtd-release="1"
  xmlns="http://sfera.sk/ws/xmtrade/isot/interfaces/ut/types/2009/04/01">
  <SenderIdentification id="24X-OT-SK-----V" coding-scheme="15"/>
  <ReceiverIdentification id="24XDSO-----Q" coding-scheme="15"/>
  <Reference id="45t"/>
  <Reason code="0" type="A03"/>
</RESPONSE>
```

Example 67 Response on success of downloading IDA results for specific auction

ISOTEDATA.943

In case of successful request processing, the structure of IDA results is returned as it was registered in the system, where message-code=943 can be found in the header.

Within the ProfileData/@profile-role attribute are used following types of results:

- SC19 – quantity of purchased electricity for positive prices,
- SC20 – quantity of sold electricity for positive prices,
- SC92 – quantity of purchased electricity for negative prices,
- SC93 – quantity of sold electricity for negative prices,
- SP20 – marginal price.

```

<ISOTEDATA id="eclb50c0-afe1-4f5e-b6a1-d94c365099e" message-code="943"
  date-time="2023-12-01T14:11:43Z" dtd-version="1" dtd-release="1" answer-required="false"
  xmlns="http://sfera.sk/ws/xmtrade/isot/interfaces/evaluations/types/2009/04/01">
  <SenderIdentification id="24X-OT-SK-----V" coding-scheme="15"/>
  <ReceiverIdentification id="24XDSO-----Q" coding-scheme="15"/>
  <Reference id="45t"/>
  <Trade trade-day="2023-12-01" auction-id="IDA1" delivery-duration="15" >
    <ProfileData profile-role="SC19">
      <Data period="1" value="50" unit="MWH"/>
      <Data period="2" value="23" unit="MWH"/>
      <Data period="3" value="65" unit="MWH"/>
      <Data period="4" value="45" unit="MWH"/>
      <Data period="5" value="12.6" unit="MWH"/>
      <Data period="6" value="65" unit="MWH"/>
      <Data period="7" value="98" unit="MWH"/>
      <Data period="8" value="78" unit="MWH"/>
      <Data period="9" value="45" unit="MWH"/>
      <Data period="10" value="41" unit="MWH"/>
      <Data period="11" value="42" unit="MWH"/>
      <Data period="12" value="12" unit="MWH"/>
      <Data period="13" value="65" unit="MWH"/>
      <Data period="14" value="31.1" unit="MWH"/>
      <Data period="15" value="32.5" unit="MWH"/>
    </ProfileData>
    <ProfileData profile-role="SC20">
      <Data period="1" value="0" unit="MWH"/>
      <Data period="2" value="64.3" unit="MWH"/>
      <Data period="3" value="0" unit="MWH"/>
      <Data period="4" value="0" unit="MWH"/>
      <Data period="5" value="0" unit="MWH"/>
      <Data period="6" value="23.4" unit="MWH"/>
      <Data period="7" value="78.9" unit="MWH"/>
      <Data period="8" value="0" unit="MWH"/>
      <Data period="9" value="0" unit="MWH"/>
      <Data period="10" value="30.1" unit="MWH"/>
      <Data period="11" value="0" unit="MWH"/>
      <Data period="12" value="0" unit="MWH"/>
      <Data period="13" value="0" unit="MWH"/>
      <Data period="14" value="50" unit="MWH"/>
      <Data period="15" value="40" unit="MWH"/>
    </ProfileData>
    <ProfileData profile-role="SP20">
      <Data period="1" value="20.45" unit="EUR"/>
      <Data period="2" value="32.45" unit="EUR"/>
      <Data period="3" value="20" unit="EUR"/>
      <Data period="4" value="20" unit="EUR"/>
      <Data period="5" value="21.65" unit="EUR"/>
      <Data period="6" value="24.95" unit="EUR"/>
      <Data period="7" value="24.35" unit="EUR"/>
      <Data period="8" value="32.65" unit="EUR"/>
      <Data period="9" value="17.65" unit="EUR"/>
      <Data period="10" value="24.87" unit="EUR"/>
      <Data period="11" value="23.98" unit="EUR"/>
      <Data period="12" value="15.45" unit="EUR"/>
      <Data period="13" value="19.87" unit="EUR"/>
      <Data period="14" value="33.54" unit="EUR"/>
      <Data period="15" value="17.65" unit="EUR"/>
    </ProfileData>
    <Party id="24XDSO-----Q" role="TO"/>
  </Trade>
</ISOTEDATA>

```

Example 68

Response containing requested IDA results

4.9.3 Notification of evaluations per periods (E-11_01)

Notification of evaluations per periods is carried out by sending a request in *CDSREQ.951* structure (message-code=951) and response with data in *RESPONSE.952* and *ISOTEDATA.953* structures.

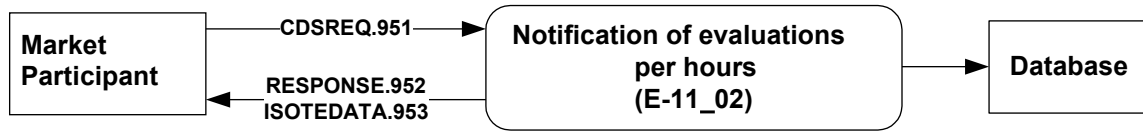

Figure 46 Scheme for IDA evaluation per periods for MPs

CDSREQ.951

To be filled out in accordance with specification of [CDSREQ](#) structure. Request is formulated for specific trading day (trade-day) and auction (auction-id).

```

<CDSREQ id="45t" message-code="951" date-time="2023-23-01T01:18:33"
  dtd-version="1" dtd-release="1"
  xmlns="http://sfera.sk/ws/xmtrade/isot/interfaces/ut/types/2009/04/01">
  <SenderIdentification id="24XDSO-----Q" coding-scheme="15"/>
  <ReceiverIdentification id="24X-OT-SK-----V" coding-scheme="15"/>
  <Trade trade-day="2023-12-01" auction-id="IDA1" />
</CDSREQ>
  
```

Example 69 Request for IDA evaluation per periods for specific auction

RESPONSE.952

In case of successful or failed request processing, response is returned in accordance with specification of [RESPONSE](#) structure, where message-code=952 can be found in the header.

```

<RESPONSE id="7cdd21c0-e21f-4e70-a617-2d55db510e8" message-code="952"
  date-time="2023-12-01T14:16:54Z" dtd-version="1" dtd-release="1"
  xmlns="http://sfera.sk/ws/xmtrade/isot/interfaces/ut/types/2009/04/01">
  <SenderIdentification id="24X-OT-SK-----V" coding-scheme="15"/>
  <ReceiverIdentification id="24XDSO-----Q" coding-scheme="15"/>
  <Reference id="45t"/>
  <Reason code="0" type="A03"/>
</RESPONSE>
  
```

Example 70 Response on success of requesting IDA evaluation per periods

ISOTEDATA.953

In the event of successful request processing, the structure of trading results is returned as it was registered in the system, where message-code=953 can be found in the header.

The following result types are used in *ProfileData/@profile-role* attribute:

- SP02 – clearing/payment for purchased electricity,
- SC02 – amount of purchased electricity,
- SP03 – clearing/payment for sold electricity,
- SC03 – amount of sold electricity,
- SP05 – fee for traded electricity,
- SC05 – amount of traded electricity (the sum of sold and purchased electricity),
- SP90 – fee for trading transactions relating to data manipulation,
- SC90 – amount of trading transactions relating to data manipulation,
- SP91 – fee for trading transactions relating to use of automated interfaces,
- SC91 – amount of trading transactions relating to use of automated interfaces,
- SP92 – clearing/payment for purchased electricity for negative prices (positive number),
- SC92 – quantity of purchased electricity for negative prices (positive number),
- SP93 – clearing/payment for sold electricity for negative prices (positive number),
- SC93 – quantity of sold electricity for negative prices (positive number).

```

<ISOTEDATA id="9d1bd4cd-5c92-4f51-adde-6253a08cfbb" message-code="953"
  date-time="2023-12-01T14:16:54Z" dtd-version="1" dtd-release="1" answer-required="false"
  xmlns="http://sfera.sk/ws/xmtrade/isot/interfaces/evaluations/types/2009/04/01">
  <SenderIdentification id="24X-OT-SK-----V" coding-scheme="15"/>
  <ReceiverIdentification id="24XDSO-----Q" coding-scheme="15"/>
  <Reference id="45t"/>
  <Trade trade-day="2023-12-01" auction-id="IDA1" delivery-duration="15" >
    <ProfileData profile-role="SP02">
      <Data period="1" value="1022.5" unit="EUR"/>
      <Data period="2" value="746.35" unit="EUR"/>
      <Data period="3" value="1300" unit="EUR"/>
      <Data period="4" value="900" unit="EUR"/>
      <Data period="5" value="272.79" unit="EUR"/>
      <Data period="6" value="1621.75" unit="EUR"/>
      <Data period="7" value="2386.3" unit="EUR"/>
      <Data period="8" value="2546.7" unit="EUR"/>
      <Data period="9" value="794.25" unit="EUR"/>
      <Data period="10" value="1019.67" unit="EUR"/>
    </ProfileData>
    <ProfileData profile-role="SC02">
      <Data period="1" value="50" unit="MWH"/>
      <Data period="2" value="23" unit="MWH"/>
      <Data period="3" value="65" unit="MWH"/>
      <Data period="4" value="45" unit="MWH"/>
      <Data period="5" value="12.6" unit="MWH"/>
      <Data period="6" value="65" unit="MWH"/>
      <Data period="7" value="98" unit="MWH"/>
      <Data period="8" value="78" unit="MWH"/>
      <Data period="9" value="45" unit="MWH"/>
      <Data period="10" value="41" unit="MWH"/>
    </ProfileData>
    <ProfileData profile-role="SP03">
      <Data period="1" value="0" unit="EUR"/>
      <Data period="2" value="2086.535" unit="EUR"/>
      <Data period="3" value="0" unit="EUR"/>
      <Data period="4" value="0" unit="EUR"/>
      <Data period="5" value="0" unit="EUR"/>
      <Data period="6" value="583.83" unit="EUR"/>
      <Data period="7" value="1921.215" unit="EUR"/>
      <Data period="8" value="0" unit="EUR"/>
      <Data period="9" value="0" unit="EUR"/>
      <Data period="10" value="748.587" unit="EUR"/>
    </ProfileData>
    <ProfileData profile-role="SC03">
      <Data period="1" value="0" unit="MWH"/>
      <Data period="2" value="64.3" unit="MWH"/>
      <Data period="3" value="0" unit="MWH"/>
      <Data period="4" value="0" unit="MWH"/>
      <Data period="5" value="0" unit="MWH"/>
      <Data period="6" value="23.4" unit="MWH"/>
      <Data period="7" value="78.9" unit="MWH"/>
      <Data period="8" value="0" unit="MWH"/>
      <Data period="9" value="0" unit="MWH"/>
      <Data period="10" value="30.1" unit="MWH"/>
    </ProfileData>
    <Party id="24XDSO-----Q" role="TO"/>
  </Trade>
</ISOTEDATA>

```

Example 71

Response containing IDA evaluation per periods

4.9.4 Notification of evaluations per day (E-05_02)

Notification of evaluations for day is carried out by sending a request in *CDSREQ.961* structure (message-code=961) and response with data in *RESPONSE.962* and *ISOTEDATA.963* structure.

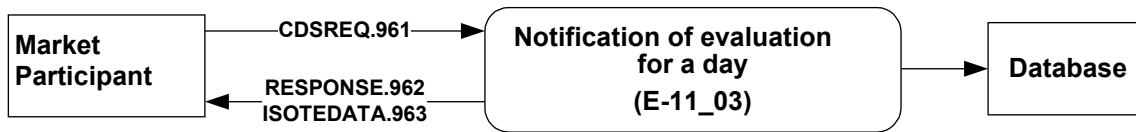

Figure 47 Schéma oznámenia vyhodnotení VDA za deň pre ÚT

CDSREQ.961

Request is formulated for specific trading day (trade-day) and optional possibility to fill specific auction (auction-id) is filled out according to the specification of [CDSREQ](#) structure

```

<CDSREQ id="45t" message-code="951" date-time="2023-12-01T01:18:33"
  dtd-version="1" dtd-release="1"
  xmlns="http://sfera.sk/ws/xmtrade/isot/interfaces/ut/types/2009/04/01">
  <SenderIdentification id="24XDSO-----Q" coding-scheme="15"/>
  <ReceiverIdentification id="24X-OT-SK-----V" coding-scheme="15"/>
  <Trade trade-day="2023-12-01" />
</CDSREQ>
  
```

Example 72 Request for downloading summary IDA evaluations per day

RESPONSE.962

In case of successful or failed request processing, response is returned according to specification of [RESPONSE](#) structure, where message-code=962 can be found in the header.

```

<RESPONSE id="8a848bad-46c2-4e3d-ab78-2c7c4545a21" message-code="962"
  date-time="2023-12-01T14:20:40Z" dtd-version="1" dtd-release="1"
  xmlns="http://sfera.sk/ws/xmtrade/isot/interfaces/ut/types/2009/04/01">
  <SenderIdentification id="24X-OT-SK-----V" coding-scheme="15"/>
  <ReceiverIdentification id="24XDSO-----Q" coding-scheme="15"/>
  <Reference id="45t"/>
  <Reason code="0" type="A03"/>
</RESPONSE>
  
```

Example 73 Response on success of requesting summary daily IDA evaluation

ISOTEDATA.963

In case of successful request processing, the structure of trading results is returned as it was registered in the system, where message-code=963 can be found in the header.

The following result types are used in *ProfileData* /@profile-role attribute:

- SP02 – clearing/payment for purchased electricity,
- SC02 – amount of purchased electricity,
- SP03 – clearing/payment for sold electricity,
- SC03 – amount of sold electricity,
- SP05 – fee for traded electricity,
- SC05 – amount of traded electricity (the sum of sold and purchased electricity),
- ST16 – monthly fee for access on day-ahead market; the last day of month is specified,
- SP90 – fee for trading transactions relating to data manipulation,
- SC90 – amount of trading transactions relating to data manipulation,
- SP91 – fee for trading transactions relating to use of automated interfaces,
- SC91 – amount of trading transactions relating to use of automated interfaces,
- SP92 – clearing/payment for purchased electricity for negative prices (positive number),
- SC92 – quantity of purchased electricity for negative prices (positive number),
- SP93 – clearing/payment for sold electricity for negative prices (positive number),

- SC93 – quantity of sold electricity for negative prices (positive number).

```
<ISOTEDATA id="526539ee-9bb7-465b-8e5c-0b660674f0f" message-code="963"
  date-time="2023-12-01T14:20:40Z" dtd-version="1" dtd-release="1" answer-required="false"
  xmlns="http://sfera.sk/ws/xmtrade/isot/interfaces/evaluations/types/2009/04/01">
  <SenderIdentification id="24X-OT-SK-----V" coding-scheme="15" />
  <ReceiverIdentification id="24XDSO-----Q" coding-scheme="15"/>
  <Reference id="45t"/>
  <Trade trade-day="2023-12-01">
    <ProfileData profile-role="SP02">
      <Data period="0" value="27875.987" unit="EUR"/>
    </ProfileData>
    <ProfileData profile-role="SC02">
      <Data period="0" value="1146.7" unit="MWH"/>
    </ProfileData>
    <ProfileData profile-role="SP03">
      <Data period="0" value="17278.838" unit="EUR"/>
    </ProfileData>
    <ProfileData profile-role="SC03">
      <Data period="0" value="639.3" unit="MWH"/>
    </ProfileData>
    <Party id="24XDSO-----Q" role="TO"/>
  </Trade>
</ISOTEDATA>
```

Example 74 Response containing summary IDA evaluation per day

4.10 Retrieval of MCC values

MCC values are available for a market participant via operations for retrieval of these values per hours for a specific trading day.

4.10.1 Processing level

Transmission systems operators report capacities assigned for the purpose of interconnection of the CR and SR day-ahead markets for the following day in the form of market coupling (MCC - Market Coupling Capacity). These capacities are stated for each hour of the following trading day for cross-border trading areas which are connected via Market Coupling. Capacities are mentioned for every profile in both directions.

Daily deadline for reception of MCC from transmission system operators is set to 9:00 am. In exceptional cases, transmission system operator is entitled to update these values by the launch time for order coupling. Market participant is notified of eventual update of MCC values after the standard deadline via ISOT system.

Functionality for downloading MCC values is not available within the web service *StatusRequest* and method *DownloadMCC* in case of requesting data for the trading day which is under the CORE regime. During the CORE regime, the cross-border capacities are calculated by a new method of so called *flow-based* matrix. Hyperlink for access to relevant *flow-based* matrix of cross-border capacities is available on the OKTE's website.

4.10.2 Notification of MCC values (E-01_02)

Notification of MCC values is carried out by request in *ESR.StatusRequest* structure and response with data in *ECAN.CapacityDocument* and *EAD.Acknowledgement* structures.



Figure 48 Notification schema of MCC values

In case of failed processing of *StatusRequest* request, only Acknowledgement containing reason for the fail is returned. In case of successful processing, confirming Acknowledgement and CapacityDocument are returned provided that MCC values exist for a given trading day.

4.10.3 ESR.StatusRequest

StatusRequest structure is used in general for retrieval of process status or information on process in accordance with *ENTSO-E* standards. The structure is in accordance with *ESR V1R1* standard and consists a single part:

- *StatusRequest* – contains details related to the entire message.

StatusRequest

Header of request for retrieval of status information contains values of particular attributes according to the following table.

Element	Value	Description	Use
Message Identification	Identification	Unique message identification Maximum 35 characters.	Required
Message Type	A13	Type of message, which status is required. According to ENTSO-E General Code List for Data Interchange. Maximum 3 characters.	Required
Process Type	A07	Type of process, which the message relates to. According to ENTSO-E General Code List for Data Interchange. Maximum 3 characters.	Required
Sender Identification	Sender EIC	Message sender identification. Entity EIC is used. Maximum 16 characters.	Required
Sender Role	A01	Message sender role. According to ENTSO-E General Code List for Data Interchange. Maximum 3 characters.	Required
Receiver Identification	24X-OT-SK-----V	Message receiver identification. EIC = 24X-OT-SK-----V is used. Maximum 16 characters.	Required

Element	Value	Description	Use
Receiver Role	A07	Message receiver role. According to ENTSO-E General Code List for Data Interchange. Maximum 3 characters.	Required
Message Date And Time	YYYY-MMDDTHH: MM:SSZ	Date of message sending. Date and time format: <ul style="list-style-type: none"> • YYYY – year, • MM – month, • DD – day, • HH – hour, • MM – minute. Date and time items are inserted into the message in UTC (Universal Time).	Required
Requested Time Interval	YYYY-MM-DDTHH:MMZ/ YYYY-MM-DDTHH:MMZ	Time interval = trading day, for which information is requested. Date and time format: <ul style="list-style-type: none"> • YYYY – year, • MM – month, • DD – day, • HH – hour, • MM – minute. Example for trading day 20.08.2009: 2009-08-19T22:00Z/2009-08-20T22:00Z Date and time items are inserted into the message in UTC (Universal Time).	Required

```
<ns:StatusRequest DtdVersion="1" DtdRelease="1"
xmlns:ns="http://sfera.sk/ws/xmtrade/isot/statusrequest/services/2009/04/01"
xmlns="http://sfera.sk/ws/xmtrade/isot/common/types/esrv1r1/2009/04/01">
  <MessageIdentification v="ce75631a99b045e98322d8912b0090b1"/>
  <MessageType v="A13"/>
  <ProcessType v="A07"/>
  <SenderIdentification v="11XSEBRATISLAVA4" codingScheme="A01"/>
  <SenderRole v="A01"/>
  <ReceiverIdentification v="24X-OT-SK-----V" codingScheme="A01"/>
  <ReceiverRole v="A07"/>
  <MessageDateTime v="2009-08-18T14:35:07Z"/>
  <RequestedTimeInterval v="2009-08-15T22:00Z/2009-08-16T22:00Z"/>
</ns:StatusRequest>
```

Example 75 Request for retrieval of MCC values

4.10.4 EAD.Acknowledgement

Acknowledgement structure (ACK, Acknowledgement Document) is used for confirmation or rejection of request reception within the communication in *ENTSO-E* structures with the ISOT system. The structure is in accordance with *EAD V5R0* standard and consists of the following parts:

- *Acknowledgement document* – contains details related to the entire message.

- *Time Series Rejection* – contains identification details of respective time series (not used in this context).
- *Time Interval Error* – contains identification details of respective value in time series (not used in this context).
- *Reason* – contains information on acceptance or rejection of the request.

Within notification of MCC values, only *Reason* part of the structure is used and the remaining parts are not relevant in this communication.

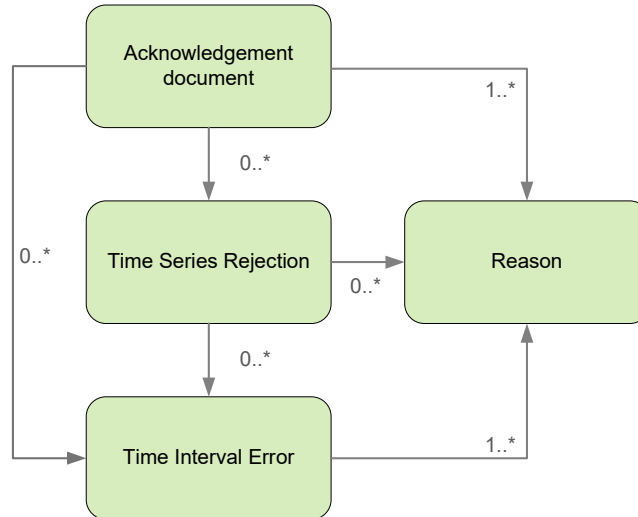

Figure 49 Scheme of Acknowledgement structure

Acknowledgement document

Header of acknowledgement document contains values of particular attributes in accordance with the following table.

Element	Value	Description	Use
Document Identification	Identification	Document identification. Maximum 35 characters.	Required
Document Date And Time	YYYY-MMDDTHH:MM:SSZ	Date of document sending. Date and time format: <ul style="list-style-type: none"> • YYYY – year, • MM – month, • DD – day, • HH – hour, • MM – minute. Date and time items are inserted into the document in UTC (Universal Time).	Required
Sender Identification	24X-OT-SK-----V	Document sender identification. EIC = 24X-OT-SK-----V is used. Maximum 16 characters.	Required

Element	Value	Description	Use
Sender Role	A07	Document sender role. According to ENTSO-E General Code List for Data Interchange. Maximum 3 characters.	Required
Receiver Identification	Entity EIC	Message receiver identification. Entity EIC is used. Maximum 16 characters.	Required
Receiver Role	A01	Message receiver role. According to ENTSO-E General Code List for Data Interchange. Maximum 3 characters.	Required
Receiving Document Identification	Identification	Identification of the original message, which the acknowledgement document refers to.	Required
Date Time Receiving Document	YYYY-MMDDTHH: MM:SSZ	Reception date of the original message in UTC (Universal Time), which the acknowledgement document refers to.	Optional

Reason

Information about acceptance or rejection of the message contains values of particular attributes in accordance with the following table.

Element	Value	Description	Use
Reason Code	AXY	Information on acceptance or rejection of the original message and reasons for its rejection. According to ENTSO-E General Code List for Data Interchange. <u>At the message level:</u> <ul style="list-style-type: none"> • A01 - Message fully accepted, • A02 - Message fully rejected, • A04 - Time interval incorrect, • A51 - Message identification or version conflict, • A53 - Receiving party incorrect, • A78 - Sender identification and/or role invalid, • A79 - Process type invalid, • A94 - Document cannot be processed by receiving system. 	Required
Reason Text	open text	Additional text justification.	Optional

```

<Acknowledgement DtdVersion="5" DtdRelease="0">
  <DocumentIdentification v="3e26b8eb34d84eec85de683bdf4ceee9" xmlns=""/>
  <DocumentDateTime v="2009-08-18T14:35:07Z" xmlns=""/>
  <SenderIdentification v="24X-OT-SK-----V" codingScheme="A01" xmlns=""/>
  <SenderRole v="A07" xmlns=""/>
  <ReceiverIdentification v="11XSEBRATISLAVA4" codingScheme="A01" xmlns=""/>
  <ReceiverRole v="A01" xmlns=""/>
  <ReceivingDocumentIdentification v="ce75631a99b045e98322d8912b0090b1" xmlns=""/>
  <DateTimeReceivingDocument v="2009-08-18T14:35:08Z" xmlns=""/>
  <Reason xmlns="">
    <ReasonCode v="A01"/>
    <ReasonText v=""/>
  </Reason>
</Acknowledgement>

```

Example 76 ACK, acknowledgement of successful reception for retrieval of MCC values

4.10.5 ECAN.CapacityDocument

CapacityDocument structure is used for retrieval of MCC values and consists of the following parts in accordance with *ECAN V4R0* standard:

- *CapacityDocument* – contains details related to the entire message (header),
- *CapacityTimeSeries* – contains details about time series,
- *Period* – contains details about time periods,
- *Interval* – contains specific MCC details in particular time units,
- *Reason* – contains details about reasons for invalidity of document or specific interval (not used).

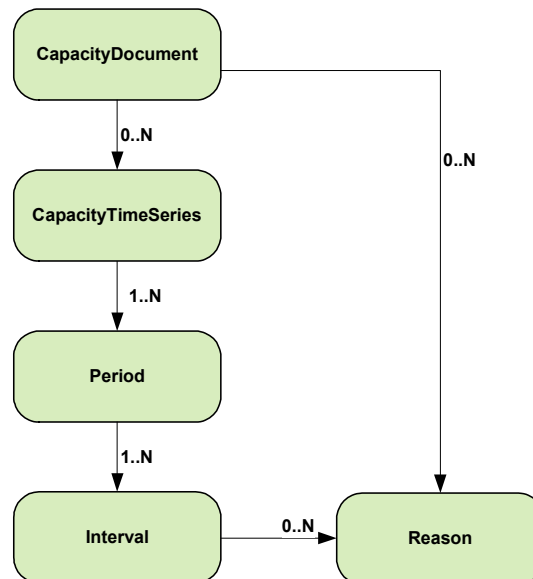

Figure 50 Schema of CapacityDocument structure

CapacityDocument

Header contains values of particular attributes in accordance with the following table.

Element	Value	Description	Use
Document Identification	Identification	Message identification. Maximum 35 characters.	Required

Element	Value	Description	Use
Document Version	non-negative number	Version of the registered document.	Required
Document Type	A13	Document type (Interconnection Capacity). According to ENTSO-E General Code List for Data Interchange. Maximum 3 characters.	Required
ProcessType	A07	Process type (Capacity Allocation). According to ENTSO-E General Code List for Data Interchange. Maximum 3 characters.	Required
Sender Identification	24X-OT-SK-----V	Message sender identification. EIC = 24X-OT-SK-----V is used Maximum 16 characters.	Required
Sender Role	A07	Message sender role. According to ENTSO-E General Code List for Data Interchange. Maximum 3 characters.	Required
Receiver Identification	Entity EIC	Message receiver identification. Entity EIC is used. Maximum 16 characters.	Required
Receiver Role	A01	Message receiver role. According to ENTSO-E General Code List for Data Interchange. Maximum 3 characters.	Required
Creation Date Time	YYYY-MMDDTHH:MM:SSZ	Date of document creation in the system. Date and time format: <ul style="list-style-type: none"> • YYYY – year, • MM – month, • DD – day, • HH – hour, • MM – minute. Date and time items are inserted into the message in UTC (Universal Time).	Required

Element	Value	Description	Use
Capacity Time Interval	YYYY-MM-DDTHH:MMZ/ YYYY-MM-DDTHH:MMZ	<p>Time interval = trading day, for which information is returned.</p> <p>Date and time format:</p> <ul style="list-style-type: none"> • YYYY – year, • MM – month, • DD - day, • HH – hour, • MM – minute. <p>Example of trading day 20.08.2009: 2009-08-19T22:00Z/2009-08-20T22:00Z</p> <p>Date and time items are inserted into the message in UTC (Universal Time).</p>	Required
Domain	10YDOM-CZ-DE-SKK	Domain	Required

CapacityTimeSeries

It covers details for cross-border profiles. Two structures are returned for profiles: *CapacityTimeSeries* or two time series. Values of particular attributes are in accordance with the following table.

Element	Value	Description	Use
TimeSeries Identification	Identification	<p>Identification of time series.</p> <p>Maximum 35 characters.</p>	Required
Business Type	A31	<p>Business type (Offered Capacity).</p> <p>According to ENTSO-E General Code List for Data Interchange.</p> <p>Maximum 3 characters.</p>	Required
Product	8716867000016	<p>Product identification.</p> <p>According to ENTSO-E General Code List for Data Interchange.</p> <p>Maximum 3 characters.</p>	Required
InArea	10YSK-SEPS-----K / 10YCZ-CEPS-----N	EIC code of area, to which energy is coming.	Required
OutArea	10YCZ-CEPS-----N / 10YSK-SEPS-----K	EIC code of area, out of which energy is coming.	Required
MeasureUnit	MAW	<p>Unit of values.</p> <p>MAW = MW</p>	Required

Element	Value	Description	Use
AuctionIdentification	DAY-AHEAD_IMPLICIT	Identification of auction = implicit auction.	Required

Period

It covers details on particular time period (trading day). Values of particular attributes are in accordance with the following table.

Element	Value	Description	Use
TimeInterval	YYYY-MM-DDTHH:MMZ/ YYYY-MM-DDTHH:MMZ	Time interval = trading day, for which information are retrieved. Date and time format: <ul style="list-style-type: none"> • YYYY - year, • MM - month, • DD – day, • HH – hour, • MM – minute. Example for trading day 20.08.2009: 2009-08-19T22:00Z/2009-08-20T22:00Z Date and time items are inserted into the message in UTC (Universal Time).	Required
Resolution	PT60M	Resolution of period = hour.	Required

Interval

It contains details on particular capacities in respective hours. Values of particular attributes are in accordance with the following table.

Element	Value	Description	Use
Pos	positive number	Position = hour within a given trading day. It starts from 1.	Required
Qty	number	Quantity	Required

```
<CapacityDocument DtdVersion="4" DtdRelease="0">
  <DocumentIdentification v="7a376855c4644ab990d190e9ccdfbe46"
    xmlns="http://sfera.sk/ws/xmtrade/isot/common/types/ecan/2009/04/01"/>
  <DocumentVersion v="1"
    xmlns="http://sfera.sk/ws/xmtrade/isot/common/types/ecan/2009/04/01"/>
  <DocumentType v="A13"
    xmlns="http://sfera.sk/ws/xmtrade/isot/common/types/ecan/2009/04/01"/>
  <ProcessType v="A07" xmlns="http://sfera.sk/ws/xmtrade/isot/common/types/ecan/2009/04/01"/>
  <SenderIdentification v="24X-OT-SK-----V" codingScheme="A01"
    xmlns="http://sfera.sk/ws/xmtrade/isot/common/types/ecan/2009/04/01"/>
  <SenderRole v="A07" xmlns="http://sfera.sk/ws/xmtrade/isot/common/types/ecan/2009/04/01"/>
  <ReceiverIdentification v="11XSEBRATISLAVA4" codingScheme="A01"
    xmlns="http://sfera.sk/ws/xmtrade/isot/common/types/ecan/2009/04/01"/>
  <ReceiverRole v="A01"
    xmlns="http://sfera.sk/ws/xmtrade/isot/common/types/ecan/2009/04/01"/>
  <CreationDateTime v="2009-08-18T14:35:07Z"
    xmlns="http://sfera.sk/ws/xmtrade/isot/common/types/ecan/2009/04/01"/>
  <CapacityTimeInterval v="2009-08-15T22:00Z/2009-08-16T22:00Z"
    xmlns="http://sfera.sk/ws/xmtrade/isot/common/types/ecan/2009/04/01"/>
  <Domain v="10YDOM-CZ-DE-SKK" codingScheme="A01"
    xmlns="http://sfera.sk/ws/xmtrade/isot/common/types/ecan/2009/04/01"/>
</CapacityDocument>
```

Example 77 Retrieved MCC values - header

```

<CapacityTimeSeries mlns="http://sfera.sk/ws/xmtrade/isot/common/types/ecan/2009/04/01">
  <TimeSeriesIdentification v="103"/>
  <BusinessType v="A31"/>
  <Product v="8716867000016"/>
  <InArea v="10YSK-SEPS-----K" codingScheme="A01"/>
  <OutArea v="10YCZ-CEPS-----N" codingScheme="A01"/>
  <MeasureUnit v="MAW"/>
  <AuctionIdentification v="DAY-AHEAD_IMPLICIT"/>
  <Period>
    <TimeInterval v="2009-08-15T22:00Z/2009-08-16T22:00Z" xmlns=""/>
    <Resolution v="PT60M" xmlns=""/>
    <Interval xmlns=""><Pos v="1"/><Qty v="80"/></Interval>
    <Interval xmlns=""><Pos v="2"/><Qty v="80"/></Interval>
    <Interval xmlns=""><Pos v="3"/><Qty v="80"/></Interval>
    <Interval xmlns=""><Pos v="4"/><Qty v="80"/></Interval>
    <Interval xmlns=""><Pos v="5"/><Qty v="80"/></Interval>
    <Interval xmlns=""><Pos v="6"/><Qty v="80"/></Interval>
    <Interval xmlns=""><Pos v="7"/><Qty v="80"/></Interval>
    <Interval xmlns=""><Pos v="8"/><Qty v="80"/></Interval>
    <Interval xmlns=""><Pos v="9"/><Qty v="80"/></Interval>
    <Interval xmlns=""><Pos v="10"/><Qty v="80"/></Interval>
    <Interval xmlns=""><Pos v="11"/><Qty v="80"/></Interval>
    <Interval xmlns=""><Pos v="12"/><Qty v="80"/></Interval>
    <Interval xmlns=""><Pos v="13"/><Qty v="80"/></Interval>
    <Interval xmlns=""><Pos v="14"/><Qty v="80"/></Interval>
    <Interval xmlns=""><Pos v="15"/><Qty v="80"/></Interval>
    <Interval xmlns=""><Pos v="16"/><Qty v="80"/></Interval>
    <Interval xmlns=""><Pos v="17"/><Qty v="80"/></Interval>
    <Interval xmlns=""><Pos v="18"/><Qty v="80"/></Interval>
    <Interval xmlns=""><Pos v="19"/><Qty v="80"/></Interval>
    <Interval xmlns=""><Pos v="20"/><Qty v="80"/></Interval>
    <Interval xmlns=""><Pos v="21"/><Qty v="80"/></Interval>
    <Interval xmlns=""><Pos v="22"/><Qty v="80"/></Interval>
    <Interval xmlns=""><Pos v="23"/><Qty v="80"/></Interval>
    <Interval xmlns=""><Pos v="24"/><Qty v="80"/></Interval>
  </Period>
</CapacityTimeSeries>
<CapacityTimeSeries mlns="http://sfera.sk/ws/xmtrade/isot/common/types/ecan/2009/04/01">
  <TimeSeriesIdentification v="101"/>
  <BusinessType v="A31"/>
  <Product v="8716867000016"/>
  <InArea v="10YCZ-CEPS-----N" codingScheme="A01"/>
  <OutArea v="10YSK-SEPS-----K" codingScheme="A01"/>
  <MeasureUnit v="MAW"/>
  <AuctionIdentification v="DAY-AHEAD_IMPLICIT"/>
  <Period>
    <TimeInterval v="2009-08-15T22:00Z/2009-08-16T22:00Z" xmlns=""/>
    <Resolution v="PT60M" xmlns=""/>
    <Interval xmlns=""><Pos v="1"/><Qty v="100"/></Interval>
    <Interval xmlns=""><Pos v="2"/><Qty v="100"/></Interval>
    <Interval xmlns=""><Pos v="3"/><Qty v="100"/></Interval>
    <Interval xmlns=""><Pos v="4"/><Qty v="100"/></Interval>
    <Interval xmlns=""><Pos v="5"/><Qty v="100"/></Interval>
    <Interval xmlns=""><Pos v="6"/><Qty v="100"/></Interval>
    <Interval xmlns=""><Pos v="7"/><Qty v="100"/></Interval>
    <Interval xmlns=""><Pos v="8"/><Qty v="100"/></Interval>
    <Interval xmlns=""><Pos v="9"/><Qty v="100"/></Interval>
    <Interval xmlns=""><Pos v="10"/><Qty v="100"/></Interval>
    <Interval xmlns=""><Pos v="11"/><Qty v="100"/></Interval>
    <Interval xmlns=""><Pos v="12"/><Qty v="100"/></Interval>
    <Interval xmlns=""><Pos v="13"/><Qty v="100"/></Interval>
    <Interval xmlns=""><Pos v="14"/><Qty v="100"/></Interval>
    <Interval xmlns=""><Pos v="15"/><Qty v="100"/></Interval>
    <Interval xmlns=""><Pos v="16"/><Qty v="100"/></Interval>
    <Interval xmlns=""><Pos v="17"/><Qty v="100"/></Interval>
    <Interval xmlns=""><Pos v="18"/><Qty v="100"/></Interval>
    <Interval xmlns=""><Pos v="19"/><Qty v="100"/></Interval>
    <Interval xmlns=""><Pos v="20"/><Qty v="100"/></Interval>
    <Interval xmlns=""><Pos v="21"/><Qty v="100"/></Interval>
    <Interval xmlns=""><Pos v="22"/><Qty v="100"/></Interval>
    <Interval xmlns=""><Pos v="23"/><Qty v="100"/></Interval>
    <Interval xmlns=""><Pos v="24"/><Qty v="100"/></Interval>
  </Period>
</CapacityTimeSeries>
</CapacityDocument>

```

Example 78 Retrieved MCC values – time series

5 LIST OF FIGURES

Figure 1	Communication scenario in domestic day-ahead market mode	8
Figure 2	Communication scenario in coordinated day-ahead market mode.....	9
Figure 3	Communication scenario of the web services in domestic intraday market mode	10
Figure 4	Communication scenario of web services and AMQP interface in intraday domestic market mode 12	
Figure 5	Communication scenario of the web services in coordinated intraday market mode	13
Figure 6	Communication scenario of web services and AMQP interface in coordinated intraday market mode	16
Figure 8	The principle of synchronous communication.....	19
Figure 9	AMQP communication concept.....	48
Figure 10	Scheme of notification messages flow on intraday market	49
Figure 11	Scheme of order structure	555555554
Figure 12	DM results structure scheme	6060606059
Figure 13	Scheme of order structure	6464646463
Figure 14	IDA results structure scheme.....	6969696968
Figure 15	Scheme of order structure	7575757574
Figure 16	Scheme of RESPONSE structure.....	8282828281
Figure 17	Scheme of RESPONSE-VDT structure	8484848483
Figure 18	Scheme of CDSREQ structure	8686868685
Figure 19	Scheme of CDSRWQ-VDT structure.....	8888888887
Figure 20	Scheme of DAM order reception	9191919190
Figure 21	Scheme of market participant order removal.....	9494949493
Figure 22	Scheme of market participant order modification	9797979796
Figure 23	Scheme of market participant order provision	101101101101100
Figure 24	Schema of market participant order reception.....	107107107107106
Figure 25	Reception of order scheme.....	108108108108107
Figure 26	Provision of orders scheme	109109109109108
Figure 27	Provision of order book data scheme	111111111111110
Figure 33	Notification schema of DM results for market participant.....	134134134134133
Figure 34	Notification schema of evaluations per hours for market participant.....	136136136136135
Figure 35	Notification schema of evaluations for day for market participant.....	138138138138137
Figure 36	Notice of an evaluation for a day scheme	139139139139138
Figure 37	Notice of an evaluation for a month scheme	141141141141140
Figure 38	Notice of an evaluation for time periods scheme.....	142142142142141
Figure 39	Sending messages scheme – order creation (AMQP notification).....	145145145145144
Figure 40	Order of sent messages scheme – order creation (AMQP notification)	146146146146145
Figure 41	Sending messages scheme – order modification (AMQP notification) .	146146146146145
Figure 42	Order of sent messages scheme – order modification (AMQP notification)	147147147147146
Figure 43	Sent messages scheme – order creation (AMQP notification).....	148148148148147
Figure 44	Sequentiality of sent messages scheme – modification of order book (AMQP notification)	148148148148147
Figure 48	Notification schema of MCC values.....	161161161161160
Figure 49	Scheme of Acknowledgement structure	164164164164163
Figure 50	Schema of CapacityDocument structure	166166166166165

6 LIST OF TABLES

Table 1	Automated interface for data exchange of processes within day-ahead order registration ..	7
Table 2	Overview of interfaces in domestic day-ahead market mode	8
Table 3	Overview of interfaces in day-ahead market mode	9
Table 4	Overview of interfaces in domestic intraday market mode	10
Table 5	Overview of AMPQ interface in domestic intraday market mode	11
Table 6	Overview of interfaces in coordinated intraday market mode	13
Table 7	Overview of AMPQ interface in coordinated intraday market mode	14
Table 8	Overview of interfaces in intraday auctions mode	17
Table 9	Overview of interfaces in the coordinated organization of day-ahead and intraday market mode 18	
Table 10	Namespace aliases	19
Table 11	Request structure description – Upload method	20
Table 12	Response structure description - Upload method	20
Table 13	Request structure description – Download method	23
Table 14	Response structure description – Download method	23
Table 15	Request structure description – Upload method	24
Table 16	Response structure description - Upload method	25
Table 17	Request structure description – Method Modify	26
Table 18	Response structure description – Method Modify	26
Table 19	Request structure description – Method Download	28
Table 20	Response structure description - Method Download	28
Table 21	Request structure description - Method Download	30
Table 22	Request structure description - Method DownloadH2HMatrix	30
Table 23	Response structure description - Method Download	30
Table 24	Request structure description –Upload method	32
Table 25	Response structure description – Upload method	32
Table 26	Request structure description – Download method	34
Table 27	Response structure description – Download method	34
Table 28	Request structure description – Download method	35
Table 29	Response structure description – Download method	36
Table 30	Request structure description – Download method	37
Table 31	Response structure description – Download method	38
Table 32	Request structure – Download method	39
Table 33	Response structure - Download method	40
Table 34	Request structure description – DownloadMCC method	41
Table 35	Response structure description – DownloadMCC method	42
Table 36	Description of web services XMtrade®/ISOT – production environment	46
Table 37	Description of web services XMtrade®/ISOT – SANDBOX environment	46
Table 38	Description of web services XMtrade®/ISOT – testing environment	47
Table 39	Data flow distribution keys tags description	50
Table 40	Message properties in metadata description	51
Table 41	Structures and data flows overview	53
Table 42	ISOTEDATA root element	55
Table 43	Message header of displayed values of particular elements	56
Table 44	Trade order element	56
Table 45	Trade order element	58
Table 46	ProfileData element of order block	59
Table 47	Data element of data block	59
Table 48	ISOTEDATA root element	60
Table 49	Displayed values message header of particular elements	61
Table 50	Trade element 1 of DM result/evaluation for a given trading day	61
Table 51	Trade element 2 of DM result/evaluation for a given trading day	62
Table 52	ProfileData element of result block	62
Table 53	Data element of data block	63
Table 54	ISOTEDATA root element	64
Table 55	Message header of displayed values of particular elements	65
Table 56	Trade order element	65
Table 57	Trade order element	67

Table 58	ProfileData element of order block	68
Table 59	Data element of data block	68
Table 60	ISOTEDATA root element	69
Table 61	Displayed values message header of particular elements	70
Table 62	Trade element 1 of DM result/evaluation for a given trading day	70
Table 63	Trade element 2 of DM result/evaluation for a given trading day	72
Table 64	ProfileData element of result block	72
Table 65	Data element of data block	73
Table 66	ISOTEDATA-VDT root element	76
Table 67	Message header displayed values of single elements	77
Table 68	Elements of order, Trade	77
Table 69	Element of order, ProfileData	79
Table 70	Element of block data, Data	80
Table 71	RESPONSE root element	82
Table 72	Message header of displayed values of particular elements	83
Table 73	Reason element	83
Table 74	Root element RESPONSE	84
Table 75	Message header of displayed values of particular elements	85
Table 76	Reason element	85
Table 77	CDSREQ root element	86
Table 78	Message header of displayed values of particular elements	87
Table 79	Trade header element	87
Table 80	CDSREQ root element	88
Table 81	Message header of displayed values of particular elements	89
Table 82	Trade header element	90
Table 83	Converter for usage of periods within intraday market	106

7 LIST OF EXAMPLES

Example 1	Submission of standard hourly sale order.....	9292929294
Example 2	Submission of simple block sale order.....	9292929294
Example 3	Response on success of order submission	9393939392
Example 4	Response with description of entered order in the system	9393939392
Example 5	Removal of specific sale order	9595959594
Example 6	Response on success of order removal.....	9696969695
Example 7	Response with description of removed order from the system.....	9696969695
Example 8	Modification of specific order.....	9898989897
Example 9	Response on success of order modification	9999999998
Example 10	Response with description of modified order	10010010040099
Example 11	Request for retrieval of orders for specific day	10110110140100
Example 12	Response on success of order provision for specific day	10110110140100
Example 13	Response containing orders for specific day	102102102402101
Example 14	Submission of 60-minutes sale order.....	107107107407106
Example 15	Response on success of order submission	107107107407106
Example 16	Response with description of entered order in the system	108108108408107
Example 17	Deactivation of order	108108108408107
Example 18	Successful modification of order response	109109109409108
Example 19	Provision of specific order	109109109409108
Example 20	Provision of all orders in given time period	109109109409108
Example 21	Successful modification of order response	110110110410109
Example 22	Response with description of two available orders	110110110410109
Example 23	Provision of order book	111111111411110
Example 24	Provision of order book for specific period length.....	112112112412111
Example 25	Response about successful processing of order book data provision request 112112112412111	
Example 26	Response with description of order book snapshot	117117117417116
Example 27	Provision of available cross-border capacities for IDM (H2H)	117117117417116
Example 28	Response about successful processing of IDM cross-border capacities data provision request.....	118118118418117
Example 29	Response containing available cross-border capacities data (data sample) 119119119419118	
Example 30	Submission of standard IDA order for sale	121121121421120
Example 31	Submission of simple block IDA order for sale	122122122422121
Example 32	Response on success of IDA order submission	122122122422121
Example 33	Response with IDA order description.....	123123123423122
Example 34	Removal of specific IDA order for sale.....	125125125425124
Example 35	Response on success of IDA order removal.....	126126126426125
Example 36	Response with description of removed IDA order.....	126126126426125
Example 37	IDA order modification.....	128128128428127
Example 38	Response on success of IDA order modification	129129129429128
Example 39	Response with description of modified IDA order	130130130430129
Example 40	Request for provision of IDA orders for specific auction.....	132132132432131
Example 41	Response on success of IDA order data provision for specific auction 132132132432131	
Example 42	Response containing IDA orders for specific auction	133133133433132
Example 43	Request for retrieval of results for specific day	134134134434133
Example 44	Response on success of results retrieval for a specific day	134134134434133
Example 45	Response containing requested results	135135135435134
Example 46	Request for retrieval of evaluations per hours for specific day	136136136436135
Example 47	Response on success of evaluations retrieval per hours for a specific day 136136136436135	
Example 48	Response containing request evaluations per hours.....	137137137437136
Example 49	Request for retrieval of evaluations cumulatively for trading day	138138138438137
Example 50	Response on success of evaluations retrieval cumulatively for trading day 138138138438137	
Example 51	Response containing requested results cumulatively for trading day	139139139439138
Example 52	Request for a summary evaluation of a day	139139139439138

Example 53	Response about successful retrieval of day evaluation	140140140140139
Example 54	Response with day evaluation results.....	140140140140139
Example 55	Request for a summary evaluation of a month	141141141141140
Example 56	Response about successful retrieval of month evaluation.....	141141141141140
Example 57	Response with month evaluation results	142142142142141
Example 58	Request for an evaluation of time periods for whole day	142142142142141
Example 59	Request for an evaluation of time periods for specific period	142142142142141
Example 60	Response about successful retrieval of time periods evaluation	143143143143142
Example 61	Response with time periods evaluation results (2 periods)	144144144144143
Example 62	Example of change in market participant order notification	147147147147146
Example 63	Example notification of change in the order book (change at the of purchase and sale and last price/quantity in the period)	150150150150149
Example 64	Example notification of change in the order book (the side of sale, different prices and last price/quantity in the period)	153153153153152
Example 65	Example of notification about change in available cross-border capacities data (H2H) 154154154154153	
Example 66	Request for downloading IDA results for specific auction.....	155155155155154
Example 67	Response on success of downloading IDA results for specific auction 155155155155154	
Example 68	Response containing requested IDA results.....	157157157157156
Example 69	Request for IDA evaluation per periods for specific auction	158158158158157
Example 70	Response on success of requesting IDA evaluation per periods	158158158158157
Example 71	Response containing IDA evaluation per periods	159159159159158
Example 72	Request for downloading summary IDA evaluations per day	160160160160159
Example 73	Response on success of requesting summary daily IDA evaluation .	160160160160159
Example 74	Response containing summary IDA evaluation per day	161161161161160
Example 75	Request for retrieval of MCC values	163163163163162
Example 76	ACK, acknowledgement of successful reception for retrieval of MCC values 166166166166165	
Example 77	Retrieved MCC values - header	170170170170169
Example 78	Retrieved MCC values – time series.....	171171171171170